

55"

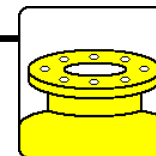

DN200

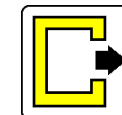

DN150

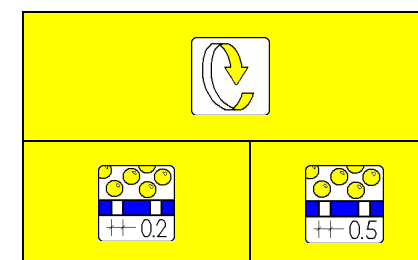
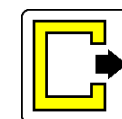
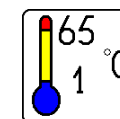
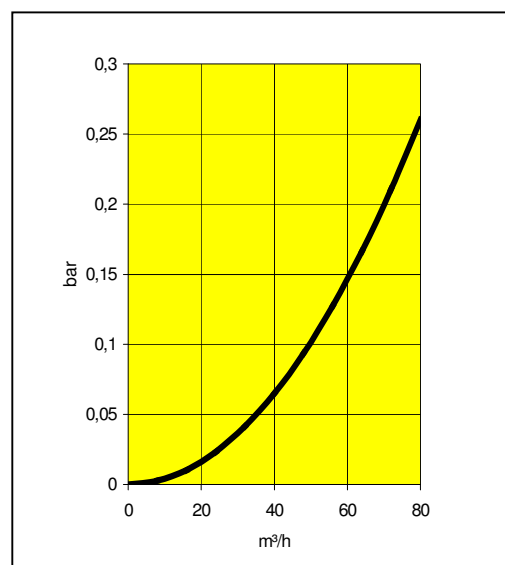
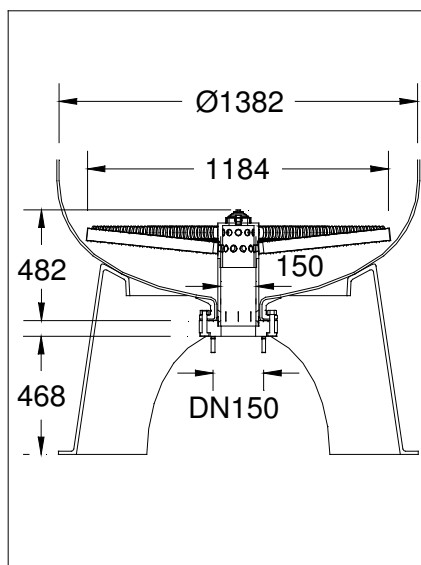
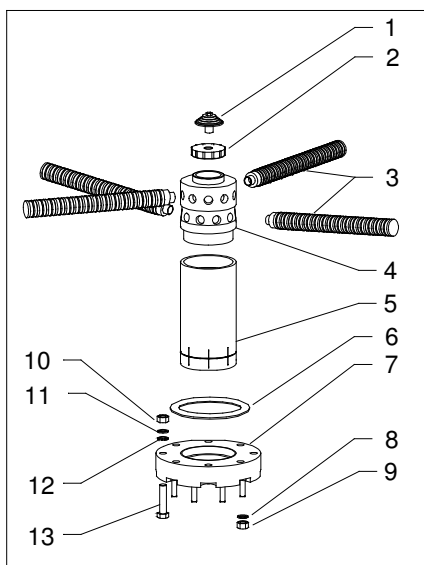

Item Position Article	Description Bezeichnung Description	Dimensions Dimensionen Dimensions	Quantity Menge Quantité	Material Material Matière	Part-Number Artikelnummer N°. d' article	
1	Filter Nozzle – Filter Duse - Bouchon Crépine	3/4"	1	PP	A-2727-10	A-2727-10
2	Hubcap – Verteilerkopfdeckel – Couvercle Distributeur	4" - 3/4"	1	PP	A-BTC8-40	A-BTC8-40
3	Lateral – Verteilerrohr – Latéral	516 mm	24	PP	A-TH02-516	A-TH05-516
4	Hub – Verteilerkopf – Distributeur	160 - 4"	1	PVC	A-2697-20	A-2697-20
5	Prolongation – Verlängerungsstück – Prolongation	160 - M160	1	PVC	A-BPR20-290	A-BPR20-290
6	Flat seal - Dichtungsring - Joint Plat	220 x 273	1	NBR	A-DN20-0D	A-DN20-0D
7	Adaptor – Adapter – Adaptateur	DN200-DN150	1	PVC	A-3100-150	A-3100-150
8	Washer - Unterlegscheibe - Rondelle	M16	8	SS	A-M16-RON	A-M16-RON
9	Nut - Mutter - Ecrou	M16	8	SS	A-M16-A4	A-M16-A4
10	Nut - Mutter - Ecrou	M20	8	SS	A-M20-A4	A-M20-A4
11	Spring washer - Federringe - Rondelle élastique	M20	8	SS	A-M20-VRO	A-M20-VRO
12	Washer - Unterlegscheibe - Rondelle	M20	16	SS	A-M20-RON	A-M20-RON
13	Bolt - Boltzen - Boulon	M20	8	SS	A-M20-120	A-M20-120



1

A-ST15055-02	A-ST15055-05
--------------	--------------

Pour tous système de distribution spécial, nous consulter

63"

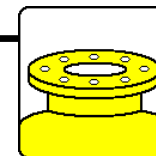

DN200

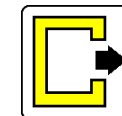
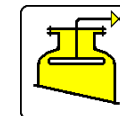
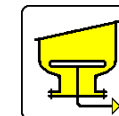
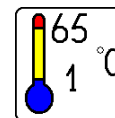

DN150

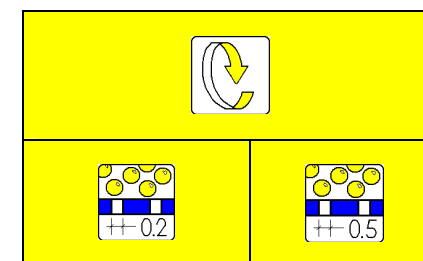
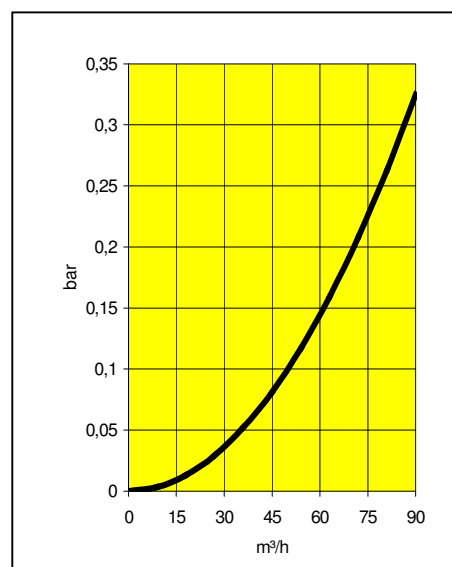
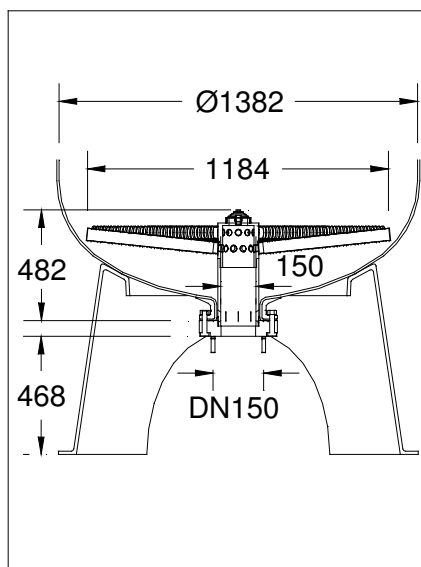
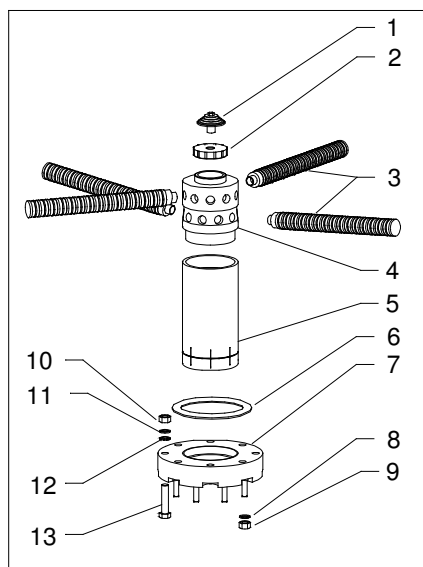

Item Position Article	Description Bezeichnung Description	Dimensions Dimensionen Dimensions	Quantity Menge Quantité	Material Material Matière	Part-Number Artikelnummer N°. d' article	
1	Filter Nozzle – Filter Duse - Bouchon Crépine	3/4"	1	PP	A-2727-10	A-2727-10
2	Hubcap – Verteilerkopfdeckel – Couvercle Distributeur	4" - 3/4"	1	PP	A-BTC8-40	A-BTC8-40
3	Lateral – Verteilerrohr – Latéral	578 mm	24	PP	A-TH02-578	A-TH05-578
4	Hub – Verteilerkopf – Distributeur	160 - 4"	1	PVC	A-2697-20	A-2697-20
5	Prolongation – Verlängerungsstück – Prolongation	160 - M160	1	PVC	A-BPR20-290	A-BPR20-290
6	Flat seal - Dichtungsring - Joint Plat	220 x 273	1	NBR	A-DN20-0D	A-DN20-0D
7	Adaptor – Adapter – Adaptateur	DN200-DN150	1	PVC	A-3100-150	A-3100-150
8	Washer - Unterlegscheibe - Rondelle	M16	8	SS	A-M16-RON	A-M16-RON
9	Nut - Mutter - Ecrou	M16	8	SS	A-M16-A4	A-M16-A4
10	Nut - Mutter - Ecrou	M20	8	SS	A-M20-A4	A-M20-A4
11	Spring washer - Federringe - Rondelle élastique	M20	8	SS	A-M20-VRO	A-M20-VRO
12	Washer - Unterlegscheibe - Rondelle	M20	16	SS	A-M20-RON	A-M20-RON
13	Bolt - Boltzen - Boulon	M20	8	SS	A-M20-120	A-M20-120



1

A-ST15063-02	A-ST15063-05
--------------	--------------

Pour tous système de distribution spécial, nous consulter

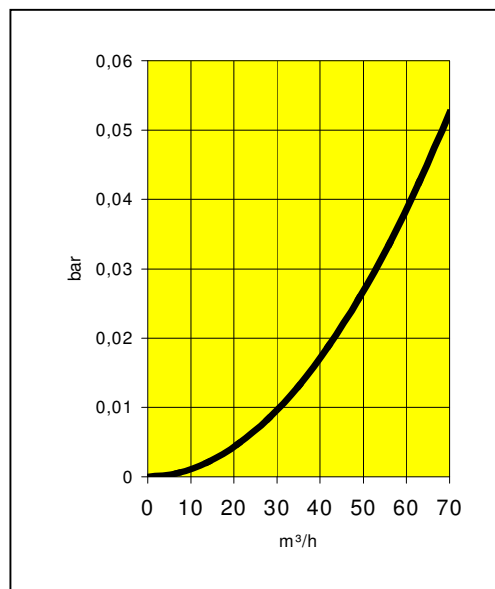
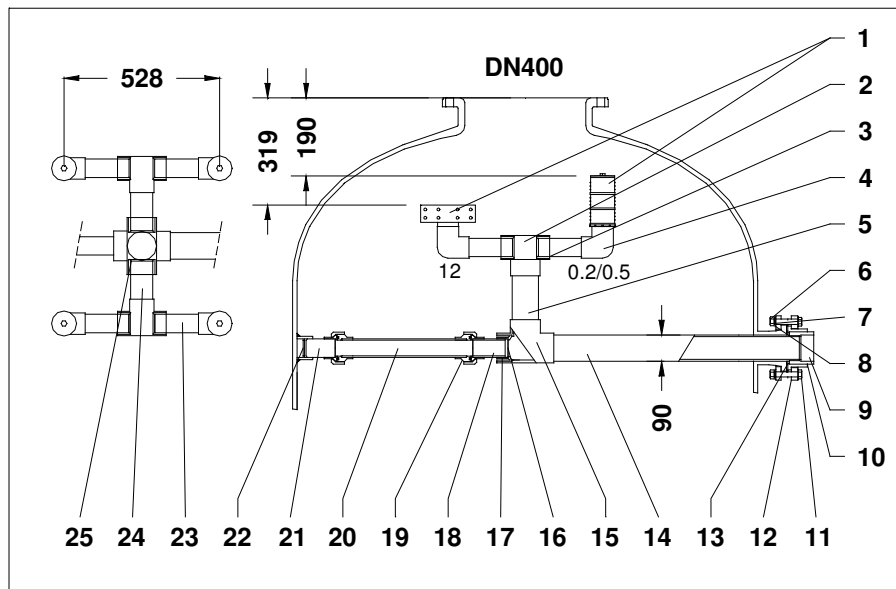

42"

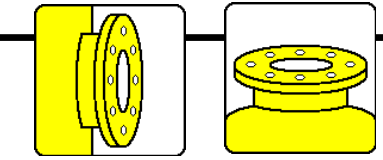

DN100

DN400

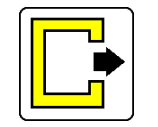
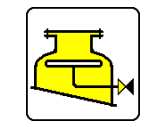
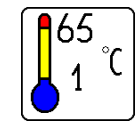

90 mm

±0.2

±0.5

±1.2

Item Position Article	Description Bezeichnung Description	Dimensions Dimensionen Dimensions	Quantity Menge Quantité	Material Material Matière	Part-Number Artikelnummer N° d' article		
1	Stack diffuser - Harzfänger - Collecteur de resine	2"	4	PP/PVC	A-2721-80	A-2600-65	G-1545-98
2	Tee - T-Stück - Té	75	2	PVC	A-2010-75	A-2010-75	A-2010-75
3	Reduction - Reduzierung - Réduction	75-63	4	PVC	A-3050-78	A-3050-78	A-3050-78
4	Elbow - Winkel - Coude	63 - 2"	4	PVC	A-2350-63	A-2350-63	A-2350-63
5	Pipe PN10 - Rohr PN10 - Tube PN10	90	143mm	PVC	A-PIPE-90	A-PIPE-90	A-PIPE-90
6	Nut - Mutter - Ecrou	M16	8	SS	A-M16-A4	A-M16-A4	A-M16-A4
7	Spring Washer - Federringe - Rondelle élastique	M16	8	SS	A-M16-VRO	A-M16-VRO	A-M16-VRO
8	Washer - Unterlegscheibe - Rondelle	M16	16	SS	A-M16-RON	A-M16-RON	A-M16-RON
9	Adapter Socket - Schraubmuffe - Manchon taraudé	3" - 90	1	PVC	A-3101-12	A-3101-12	A-3101-12
10	Collar - Bundbuchse - Collet	110	1	PVC	A-3721-11	A-3721-11	A-3721-11
11	Bolt - Bolz - Boulon	M16 x 100	8	SS	A-2100-66	A-2100-66	A-2100-66
12	Flange - Flansch - Bride	DN100	1	PVC	A-3721-10	A-3721-10	A-3721-10
13	Flat seal - Dichtung - Joint	DN100	1	NBR	A-2600-67	A-2600-67	A-2600-67
...	Continued on page 2 - Fortsetzung auf Seite 2 - Continuation sur page 2	...	...	...	...	...	...

Pour tous système de distribution spécial, nous consulter

**STRUCTURAL**  
GROUP

42"

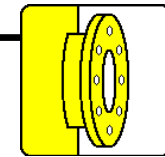

DN100

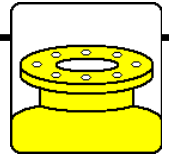

DN400



Item Position Article	Description Bezeichnung Description	Dimensions Dimensionen Dimensions	Quantity Menge Quantité	Material Material Matière	Part-Number Artikelnummer N°. d' article		
...	Continued from page 1 - Fortzetsung von Zeite 1 - Continuation de page 1	...	...	...	...	...	...
14	Pipe PN16 - Rohr PN16 - Tube PN16	90 - 3" - 675mm	1	PVC	A-PVC3-90	A-PVC3-90	A-PVC3-90
15	Tee - T-Stück - Té	90	2	PVC	A-2010-90	A-2010-90	A-2010-90
16	Disk - Scheibe - Disque	63	1	PVC	A-DISK-63	A-DISK-63	A-DISK-63
17	Reduction - Reduzierung - Réduction	90 - 63	1	PVC	A-3050-91	A-3050-91	A-3050-91
18	Pipe PN10 - Rohr PN10 - Tube PN10	63	100mm	PVC	G-19-2394	G-19-2394	G-19-2394
19	Adapter union - Verschraubung - Raccord union	63	2	PVC	A-3600-63	A-3600-63	A-3600-63
20	Pipe PN10 - Rohr PN10 - Tube PN10	63	238mm	PVC	G-19-2394	G-19-2394	G-19-2394
21	Support - Unterstüztzung - Appui	63 x 100	1	PVC	A-SUPVC-63	A-SUPVC-63	A-SUPVC-63
22	Support Socket - Unterstüztzungsmuffe - Machon d'appui	63	1	PE	A-SUPE-63	A-SUPE-63	A-SUPE-63
23	Pipe PN10 - Rohr PN10 - Tube PN10	63	184mm	PVC	G-19-2394	G-19-2394	G-19-2394
24	Pipe PN10 - Rohr PN10 - Tube PN10	75	123mm	PVC	A-PVC-075	A-PVC-075	A-PVC-075
25	Reduction - Reduzierung - Réduction	90 - 75	2	PVC	A-3050-92	A-3050-92	A-3050-92

A-UP9042-02	A-UP9042-05	A-UP9042-12
-------------	-------------	-------------

Pour tous système de distribution spécial, nous consulter

**STRUCTURAL**  
GROUP

48"

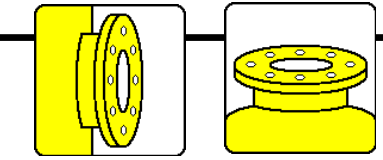

DN100

DN400

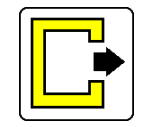
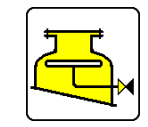
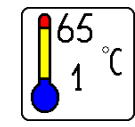

90 mm

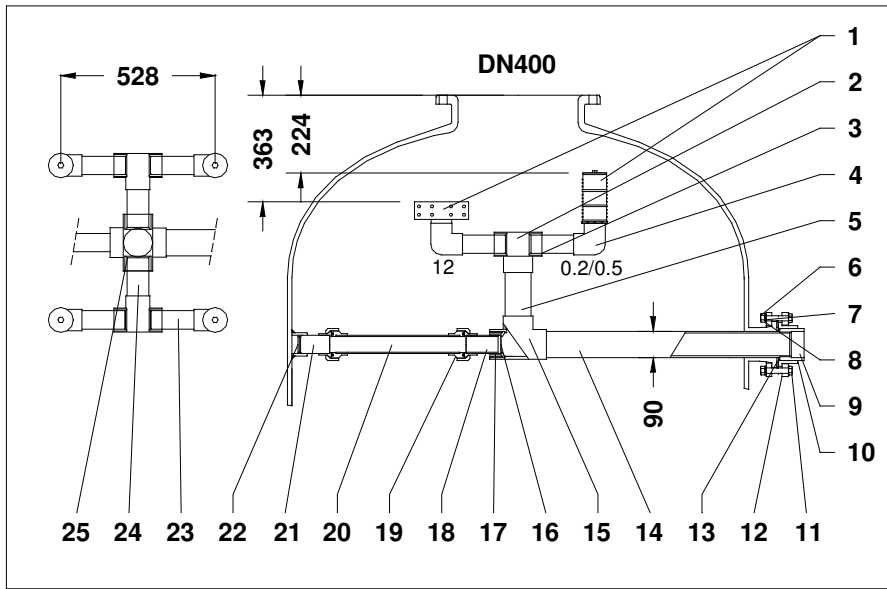
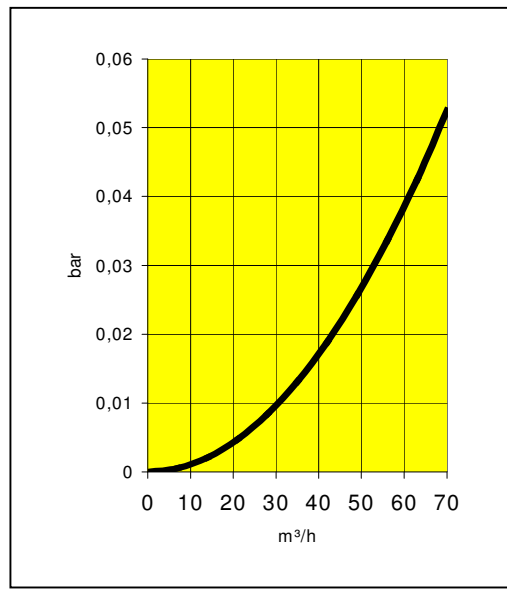

±0.2

±0.5

±1.2

Item Position Article	Description Bezeichnung Description	Dimensions Dimensionen Dimensions	Quantity Menge Quantité	Material Material Matière	Part-Number Artikelnummer N° d' article		
1	Stack diffuser - Harzfänger - Collecteur de resine	2"	4	PP/PVC	A-2721-80	A-2600-65	G-1545-98
2	Tee - T-Stück - Té	75	2	PVC	A-2010-75	A-2010-75	A-2010-75
3	Reduction - Reduzierung - Réduction	75-63	4	PVC	A-3050-78	A-3050-78	A-3050-78
4	Elbow - Winkel - Coude	63 - 2"	4	PVC	A-2350-63	A-2350-63	A-2350-63
5	Pipe PN10 - Rohr PN10 - Tube PN10	90	143mm	PVC	A-PIPE-90	A-PIPE-90	A-PIPE-90
6	Nut - Mutter - Ecrou	M16	8	SS	A-M16-A4	A-M16-A4	A-M16-A4
7	Spring Washer - Federringe - Rondelle élastique	M16	8	SS	A-M16-VRO	A-M16-VRO	A-M16-VRO
8	Washer - Unterlegscheibe - Rondelle	M16	16	SS	A-M16-RON	A-M16-RON	A-M16-RON
9	Adapter Socket - Schraubmuffe - Manchon taraudé	3" - 90	1	PVC	A-3101-12	A-3101-12	A-3101-12
10	Collar - Bundbuchse - Collet	110	1	PVC	A-3721-11	A-3721-11	A-3721-11
11	Bolt - Bolz - Boulon	M16 x 100	8	SS	A-2100-66	A-2100-66	A-2100-66
12	Flange - Flansch - Bride	DN100	1	PVC	A-3721-10	A-3721-10	A-3721-10
13	Flat seal - Dichtung - Joint	DN100	1	NBR	A-2600-67	A-2600-67	A-2600-67
...	Continued on page 2 - Fortsetzung auf Seite 2 - Continuation sur page 2	...	...	...	...	...	...

Pour tous système de distribution spécial, nous consulter

48"

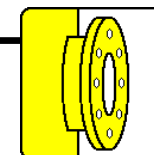

DN100

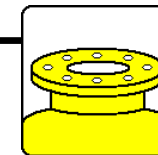

DN400

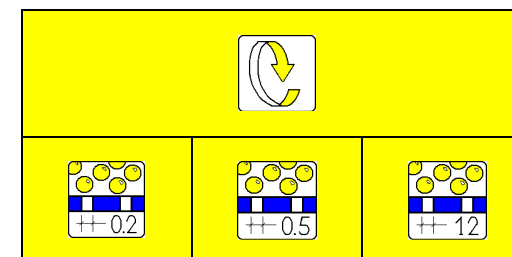

Item Position Article	Description Bezeichnung Description	Dimensions Dimensionen Dimensions	Quantity Menge Quantité	Material Material Matière	Part-Number Artikelnummer N°. d' article		
...	Continued from page 1 - Fortzetsung von Zeite 1 - Continuation de page 1	...	...	...	...	...	...
14	Pipe PN16 - Rohr PN16 - Tube PN16	90 - 3" - 750mm	1	PVC	A-PVC4-90	A-PVC4-90	A-PVC4-90
15	Tee - T-Stück - Té	90	2	PVC	A-2010-90	A-2010-90	A-2010-90
16	Disk - Scheibe - Disque	63	1	PVC	A-DISK-63	A-DISK-63	A-DISK-63
17	Reduction - Reduzierung - Réduction	90 - 63	1	PVC	A-3050-91	A-3050-91	A-3050-91
18	Pipe PN10 - Rohr PN10 - Tube PN10	63	100mm	PVC	G-19-2394	G-19-2394	G-19-2394
19	Adapter union - Verschraubung - Raccord union	63	2	PVC	A-3600-63	A-3600-63	A-3600-63
20	Pipe PN10 - Rohr PN10 - Tube PN10	63	257mm	PVC	G-19-2394	G-19-2394	G-19-2394
21	Support - Unterstüztzung - Appui	63 x 100	1	PVC	A-SUPVC-63	A-SUPVC-63	A-SUPVC-63
22	Support Socket - Unterstüztzungsmuffe - Machon d'appui	63	1	PE	A-SUPE-63	A-SUPE-63	A-SUPE-63
23	Pipe PN10 - Rohr PN10 - Tube PN10	63	184mm	PVC	G-19-2394	G-19-2394	G-19-2394
24	Pipe PN10 - Rohr PN10 - Tube PN10	75	123mm	PVC	A-PVC-075	A-PVC-075	A-PVC-075
25	Reduction - Reduzierung - Réduction	90 - 75	2	PVC	A-3050-92	A-3050-92	A-3050-92

A-UP9048-02	A-UP9048-05	A-UP9048-12
-------------	-------------	-------------

Pour tous système de distribution spécial, nous consulter

55"

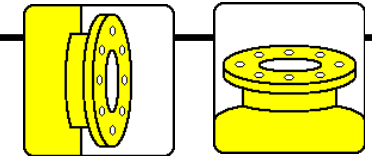

DN100

DN400

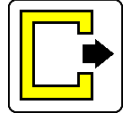
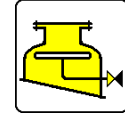

90 mm

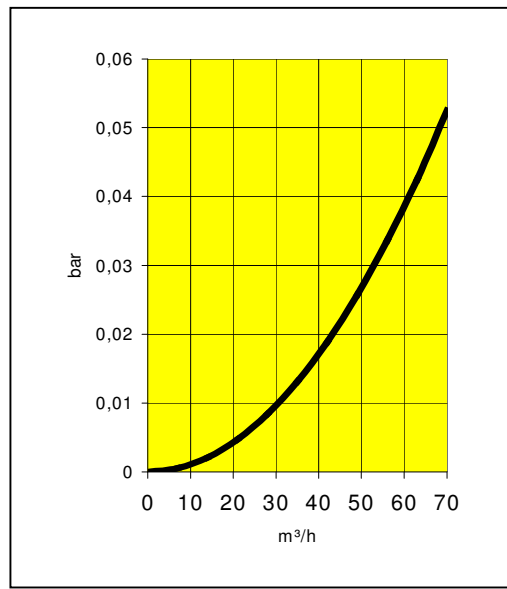
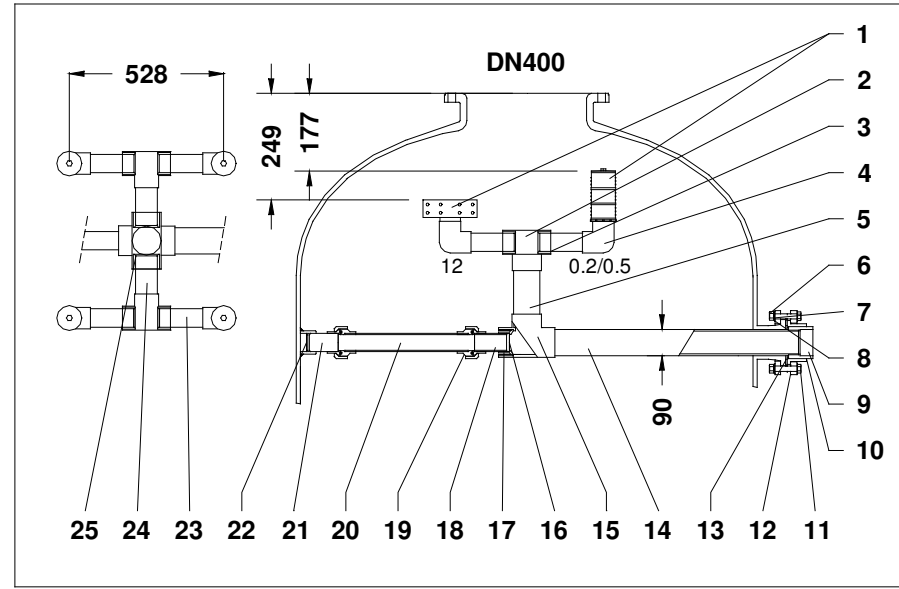
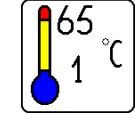

Item Position Article	Description Bezeichnung Description	Dimensions Dimensionen Dimensions	Quantity Menge Quantité	Material Material Matière	Part-Number Artikelnummer N° d' article		
1	Stack diffuser - Harzfänger - Collecteur de resine	2"	4	PP/PVC	A-2721-80	A-2600-65	G-1545-98
2	Tee - T-Stück - Té	75	2	PVC	A-2010-75	A-2010-75	A-2010-75
3	Reduction - Reduzierung - Réduction	75-63	4	PVC	A-3050-78	A-3050-78	A-3050-78
4	Elbow - Winkel - Coude	63 - 2"	4	PVC	A-2350-63	A-2350-63	A-2350-63
5	Pipe PN10 - Rohr PN10 - Tube PN10	90	161mm	PVC	A-PIPE-90	A-PIPE-90	A-PIPE-90
6	Nut - Mutter - Ecrou	M16	8	SS	A-M16-A4	A-M16-A4	A-M16-A4
7	Spring Washer - Federringe - Rondelle élastique	M16	8	SS	A-M16-VRO	A-M16-VRO	A-M16-VRO
8	Washer - Unterlegscheibe - Rondelle	M16	16	SS	A-M16-RON	A-M16-RON	A-M16-RON
9	Adapter Socket - Schraubmuffe - Manchon taraudé	3" - 90	1	PVC	A-3101-12	A-3101-12	A-3101-12
10	Collar - Bundbuchse - Collet	110	1	PVC	A-3721-11	A-3721-11	A-3721-11
11	Bolt - Bolz - Boulon	M16 x 100	8	SS	A-2100-66	A-2100-66	A-2100-66
12	Flange - Flansch - Bride	DN100	1	PVC	A-3721-10	A-3721-10	A-3721-10
13	Flat seal - Dichtung - Joint	DN100	1	NBR	A-2600-67	A-2600-67	A-2600-67
...	Continued on page 2 - Fortsetzung auf Zeite 2 - Continuation sur page 2	...	...	...	...	...	...

Pour tous système de distribution spécial, nous consulter

55"

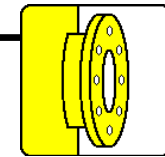

DN100

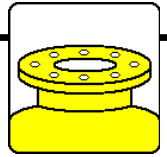

DN400

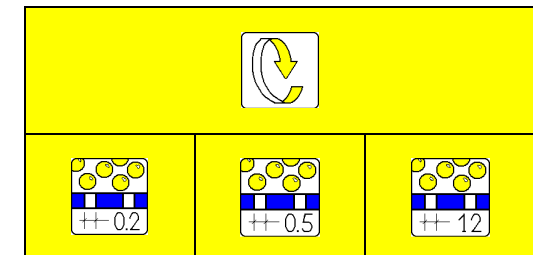

Item Position Article	Description Bezeichnung Description	Dimensions Dimensionen Dimensions	Quantity Menge Quantité	Material Material Matière	Part-Number Artikelnummer N°. d' article		
...	Continued from page 1 - Fortzetsung von Zeite 1 - Continuation de page 1	...	...	...	...	...	...
14	Pipe PN16 - Rohr PN16 - Tube PN16	90 - 3" - 847mm	1	PVC	A-PVC5-90	A-PVC5-90	A-PVC5-90
15	Tee - T-Stück - Té	90	2	PVC	A-2010-90	A-2010-90	A-2010-90
16	Disk - Scheibe - Disque	63	1	PVC	A-DISK-63	A-DISK-63	A-DISK-63
17	Reduction - Reduzierung - Réduction	90 - 63	1	PVC	A-3050-91	A-3050-91	A-3050-91
18	Pipe PN10 - Rohr PN10 - Tube PN10	63	100mm	PVC	G-19-2394	G-19-2394	G-19-2394
19	Adapter union - Verschraubung - Raccord union	63	2	PVC	A-3600-63	A-3600-63	A-3600-63
20	Pipe PN10 - Rohr PN10 - Tube PN10	63	346mm	PVC	G-19-2394	G-19-2394	G-19-2394
21	Support - Unterstüztzung - Appui	63 x 100	1	PVC	A-SUPVC-63	A-SUPVC-63	A-SUPVC-63
22	Support Socket - Unterstüztzungsmuffe - Machon d'appui	63	1	PE	A-SUPE-63	A-SUPE-63	A-SUPE-63
23	Pipe PN10 - Rohr PN10 - Tube PN10	63	184mm	PVC	G-19-2394	G-19-2394	G-19-2394
24	Pipe PN10 - Rohr PN10 - Tube PN10	75	123mm	PVC	A-PVC-075	A-PVC-075	A-PVC-075
25	Reduction - Reduzierung - Réduction	90 - 75	2	PVC	A-3050-92	A-3050-92	A-3050-92

A-UP9055-02	A-UP9055-05	A-UP9055-12
-------------	-------------	-------------

Pour tous système de distribution spécial, nous consulter



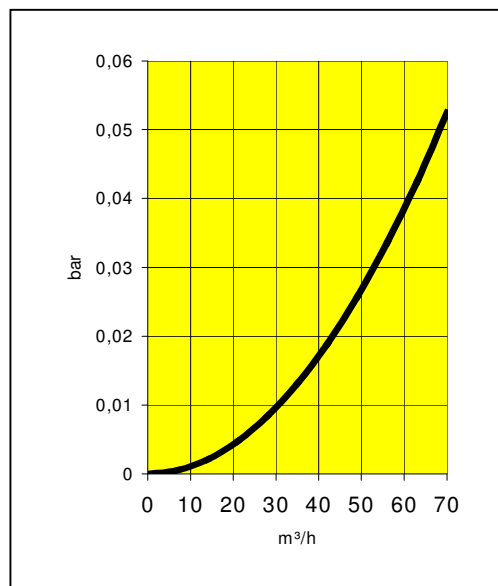
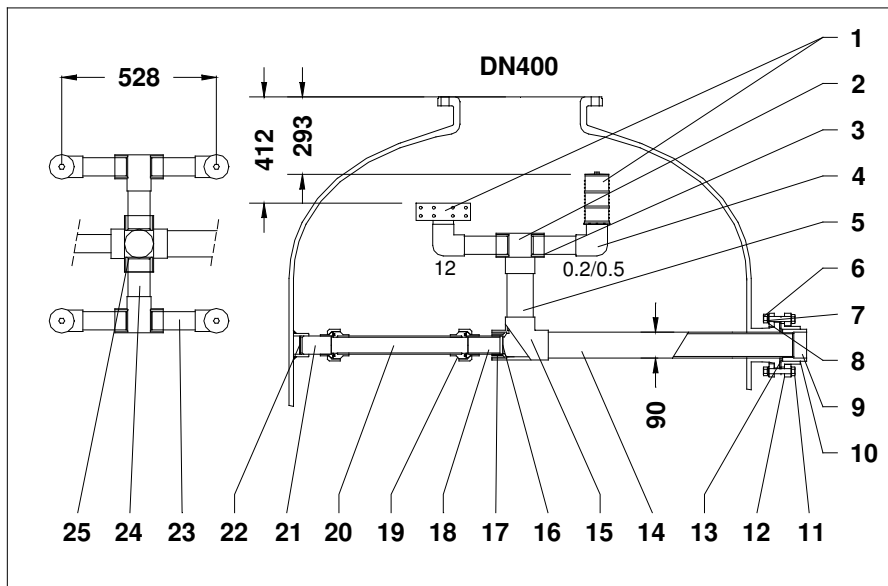

63"

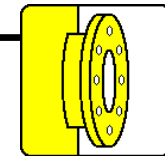

DN100

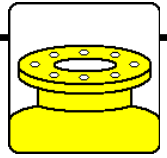

DN400

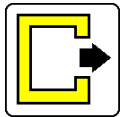
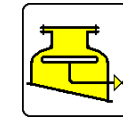
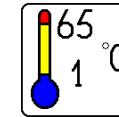

90 mm



±0.2

±0.5

±1.2

Item Position Article	Description Bezeichnung Description	Dimensions Dimensionen Dimensions	Quantity Menge Quantité	Material Material Matière	Part-Number Artikelnummer N° d' article		
1	Stack diffuser - Harzfänger - Collecteur de resine	2"	4	PP/PVC	A-2721-80	A-2600-65	G-1545-98
2	Tee - T-Stück - Té	75	2	PVC	A-2010-75	A-2010-75	A-2010-75
3	Reduction - Reduzierung - Réduction	75-63	4	PVC	A-3050-78	A-3050-78	A-3050-78
4	Elbow - Winkel - Coude	63 - 2"	4	PVC	A-2350-63	A-2350-63	A-2350-63
5	Pipe PN10 - Rohr PN10 - Tube PN10	90	188mm	PVC	A-PIPE-90	A-PIPE-90	A-PIPE-90
6	Nut - Mutter - Ecrou	M16	8	SS	A-M16-A4	A-M16-A4	A-M16-A4
7	Spring Washer - Federringe - Rondelle élastique	M16	8	SS	A-M16-VRO	A-M16-VRO	A-M16-VRO
8	Washer - Unterlegscheibe - Rondelle	M16	16	SS	A-M16-RON	A-M16-RON	A-M16-RON
9	Adapter Socket - Schraubmuffe - Manchon taraudé	3" - 90	1	PVC	A-3101-12	A-3101-12	A-3101-12
10	Collar - Bundbuchse - Collet	110	1	PVC	A-3721-11	A-3721-11	A-3721-11
11	Bolt - Bolz - Boulon	M16 x 100	8	SS	A-2100-66	A-2100-66	A-2100-66
12	Flange - Flansch - Bride	DN100	1	PVC	A-3721-10	A-3721-10	A-3721-10
13	Flat seal - Dichtung - Joint	DN100	1	NBR	A-2600-67	A-2600-67	A-2600-67
...	Continued on page 2 - Fortsetzung auf Zeite 2 - Continuation sur page 2	...	...	...	...	...	...

Pour tous système de distribution spécial, nous consulter

63"

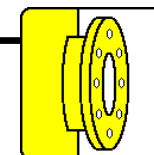

DN100

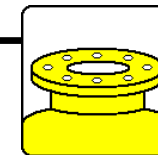

DN400



Item Position Article	Description Bezeichnung Description	Dimensions Dimensionen Dimensions	Quantity Menge Quantité	Material Material Matière	Part-Number Artikelnummer N°. d' article		
...	Continued from page 1 - Fortzetsung von Zeite 1 - Continuation de page 1	...	...	...	...	...	...
14	Pipe PN16 - Rohr PN16 - Tube PN16	90 - 3" - 856mm	1	PVC	A-PVC6-90	A-PVC6-90	A-PVC6-90
15	Tee - T-Stück - Té	90	2	PVC	A-2010-90	A-2010-90	A-2010-90
16	Disk - Scheibe - Disque	63	1	PVC	A-DISK-63	A-DISK-63	A-DISK-63
17	Reduction - Reduzierung - Réduction	90 - 63	1	PVC	A-3050-91	A-3050-91	A-3050-91
18	Pipe PN10 - Rohr PN10 - Tube PN10	63	100mm	PVC	G-19-2394	G-19-2394	G-19-2394
19	Adapter union - Verschraubung - Raccord union	63	2	PVC	A-3600-63	A-3600-63	A-3600-63
20	Pipe PN10 - Rohr PN10 - Tube PN10	63	435mm	PVC	G-19-2394	G-19-2394	G-19-2394
21	Support - Unterstüztzung - Appui	63 x 100	1	PVC	A-SUPVC-63	A-SUPVC-63	A-SUPVC-63
22	Support Socket - Unterstüztzungsmuffe - Machon d'appui	63	1	PE	A-SUPE-63	A-SUPE-63	A-SUPE-63
23	Pipe PN10 - Rohr PN10 - Tube PN10	63	184mm	PVC	G-19-2394	G-19-2394	G-19-2394
24	Pipe PN10 - Rohr PN10 - Tube PN10	75	123mm	PVC	A-PVC-075	A-PVC-075	A-PVC-075
25	Reduction - Reduzierung - Réduction	90 - 75	2	PVC	A-3050-92	A-3050-92	A-3050-92

A-UP9063-02

A-UP9063-05

A-UP9063-12

Pour tous système de distribution spécial, nous consulter

# 42" ... 79"

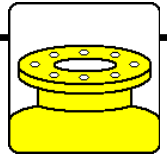

**DN400**

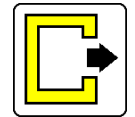
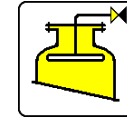

**DN80**

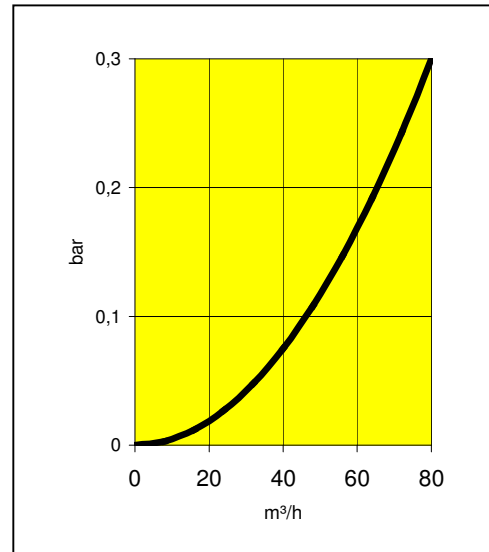
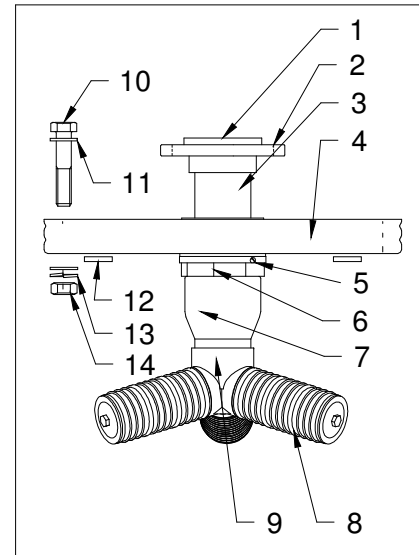
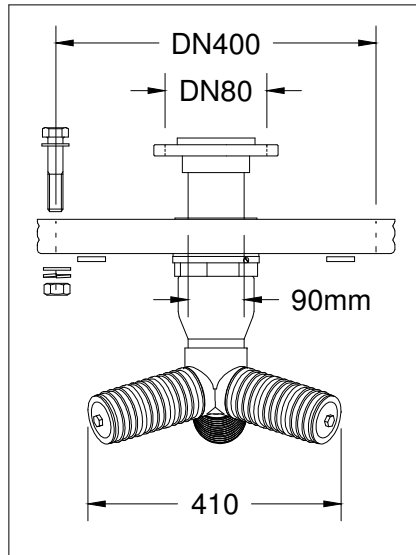
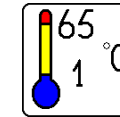

Item Position Article	Description Bezeichnung Description	Dimensions Dimensionen Dimensions	Quantity Menge Quantité	Material Material Matière	Part-Number Artikelnummer N°. d' article		
1	Collar – Bundbuchse - Collet	90mm	1	PVC	A-3720-91	A-3720-91	A-3720-91
2	Flange – Flansch - Bride	DN80	1	PP-GF	X-1V-IP80	X-1V-IP80	X-1V-IP80
3	Pipe - Rohr - Tube	90	175mm	PVC	A-PIPE-90	A-PIPE-90	A-PIPE-90
4	Flange – Flansch - Bride	DN400	1	EP-GF/LLDPE	A-MACH-DN400DN80	A-MACH-DN400DN80	A-MACH-DN400DN80
5	Screw – Schraube - Vis	M5 x 8	2	PA	A-DIN84M5-8	A-DIN84M5-8	A-DIN84M5-8
6	Table Duct – Durchführung – Traversée de paroi	90 - 110	1	PVC	A-5160-90	A-5160-90	A-5160-90
7	Adaptor nipple – Gewindestück – Embout fileté	110 – 3 BSP	1	PVC	A-1401-45	A-1401-45	A-1401-45
8	Stack Diffuser – Harzfänger – Collecteur de resine	180	3	PP	A-2740--	A-2746--	A-2747--
9	Hub – Verteilerkopf - Distributeur	3 BSP	1	PP	ATD-H30-00	ATD-H30-00	ATD-H30-00
10	Bolt – Bolzen - Boulon	M24	16	RVS	A-M24-130	A-M24-130	A-M24-130
11	Washer – Unterlegscheibe - Rondelle	M24	32	RVS	A-M24-RON	A-M24-RON	A-M24-RON
12	Flat Seal – Dichtung - Joint	DN400	1	NBR	A-DN40-0D	A-DN40-0D	A-DN40-0D
13	Spring Washer – Federringe – Rondelle élastique	M24	16	RVS	A-M24-VRO	A-M24-VRO	A-M24-VRO
14	Nut – Mutter - Erou	M24	16	RVS	A-M24-A4	A-M24-A4	A-M24-A4

<b>A-TM90-02</b>	<b>A-TM90-05</b>	<b>A-TM90-12</b>
------------------	------------------	------------------

Pour tous système de distribution spécial, nous consulter

42"

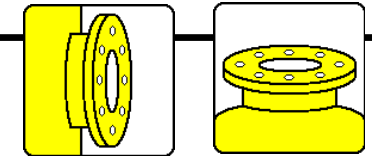

DN150

DN400

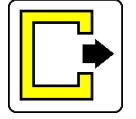
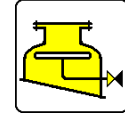

125 mm

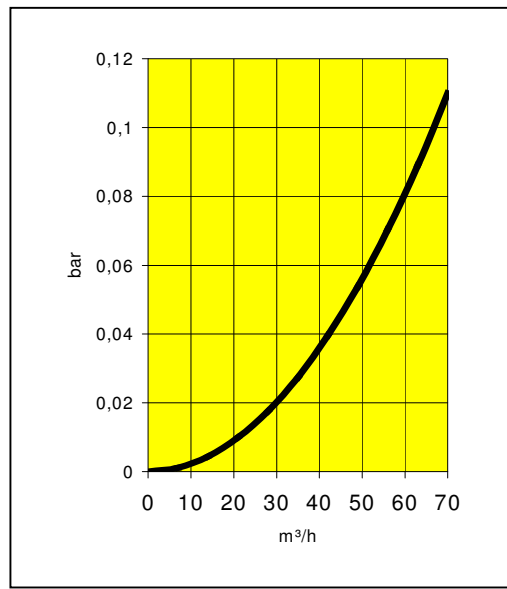
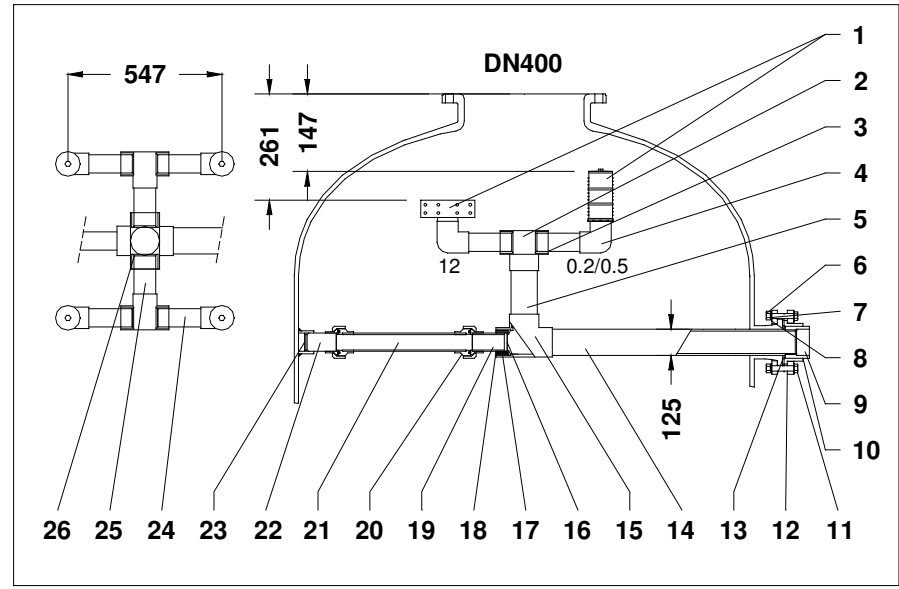
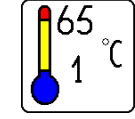

±0.2

±0.5

±12

Item Position Article	Description Bezeichnung Description	Dimensions Dimensionen Dimensions	Quantity Menge Quantité	Material Material Matière	Part-Number Artikelnummer N° d' article		
1	Stack diffuser - Harzfänger - Collecteur de resine	2"	4	PP/PVC	A-2721-80	A-2600-65	G-1545-98
2	Tee - T-Stück - Té	90	2	PVC	A-2010-90	A-2010-90	A-2010-90
3	Reduction - Reduzierung - Réduction	90-63	4	PVC	A-3050-91	A-3050-91	A-3050-91
4	Elbow - Winkel - Coude	63 - 2"	4	PVC	A-2350-63	A-2350-63	A-2350-63
5	Pipe PN10 - Rohr PN10 - Tube PN10	125	165mm	PVC	A-PIPE-125	A-PIPE-125	A-PIPE-125
6	Nut - Mutter - Ecrou	M20	8	SS	A-M20-A4	A-M20-A4	A-M20-A4
7	Spring Washer - Federringe - Rondelle élastique	M20	8	SS	A-M20-VRO	A-M20-VRO	A-M20-VRO
8	Washer - Unterlegscheibe - Rondelle	M20	16	SS	A-M20-RON	A-M20-RON	A-M20-RON
9	Adapter Socket - Schraubmuffe - Manchon taraudé	4.5" - 125	1	PVC	A-3101-60	A-3101-60	A-3101-60
10	Collar - Bundbuchse - Collet	160	1	PVC	A-3721-61	A-3721-61	A-3721-61
11	Bolt - Bolz - Boulon	M20 x 120	8	SS	A-M20-120	A-M20-120	A-M20-120
12	Flange - Flansch - Bride	DN150	1	PVC	A-3721-60	A-3721-60	A-3721-60
13	Flat seal - Dichtung - Joint	DN150	1	NBR	A-2600-150	A-2600-150	A-2600-150
...	Continued on page 2 - Fortzetsung auf Zeite 2 - Continuation sur page 2	...	...	...	...	...	...

Pour tous système de distribution spécial, nous consulter

42"

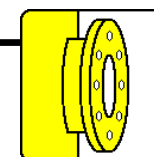

DN150

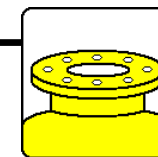

DN400



Item Position Article	Description Bezeichnung Description	Dimensions Dimensionen Dimensions	Quantity Menge Quantité	Material Material Matière	Part-Number Artikelnummer N° d' article		
...	Continued from page 1 - Fortzsetzung von Zeite 1 - Continuation de page 1	...	...	...	...	...	...
14	Pipe PN16 - Rohr PN16 - Tube PN16	125 - 4.5" - 661	1	PVC	A-PVC6-125	A-PVC6-125	A-PVC6-125
15	Tee - T-Stück - Té	125	2	PVC	A-2011-25	A-2011-25	A-2011-25
16	Disk - Scheibe - Disque	63	1	PVC	A-DISK-63	A-DISK-63	A-DISK-63
17	Reduction - Reduzierung - Réduction	90 - 63	1	PVC	A-3050-91	A-3050-91	A-3050-91
18	Reduction - Reduzierung - Réduction	125 - 90	1	PVC	A-3051-26	A-3051-26	A-3051-26
19	Pipe PN10 - Rohr PN10 - Tube PN10	63	100mm	PVC	G-19-2394	G-19-2394	G-19-2394
20	Adapter union - Verschraubung - Raccord union	63	2	PVC	A-3600-63	A-3600-63	A-3600-63
21	Pipe PN10 - Rohr PN10 - Tube PN10	63	141mm	PVC	G-19-2394	G-19-2394	G-19-2394
22	Support - Unterstützung - Appui	63 x 100	1	PVC	A-SUPVC-63	A-SUPVC-63	A-SUPVC-63
23	Support Socket - Unterstützungsmuffe - Machon d'appui	63	1	PE	A-SUPE-63	A-SUPE-63	A-SUPE-63
24	Pipe PN10 - Rohr PN10 - Tube PN10	63	192mm	PVC	G-19-2394	G-19-2394	G-19-2394
25	Pipe PN10 - Rohr PN10 - Tube PN10	90	155mm	PVC	A-PIPE-90	A-PIPE-90	A-PIPE-90
26	Reduction - Reduzierung - Réduction	125 - 90	2	PVC	A-3051-26	A-3051-26	A-3051-26

A-UP12542-02

A-UP12542-05

A-UP12542-12

Pour tous système de distribution spécial, nous consulter

48"

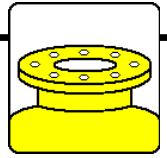
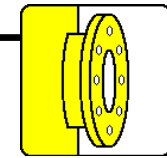

DN150

DN400

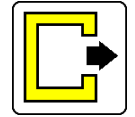
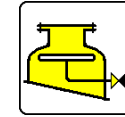

125 mm

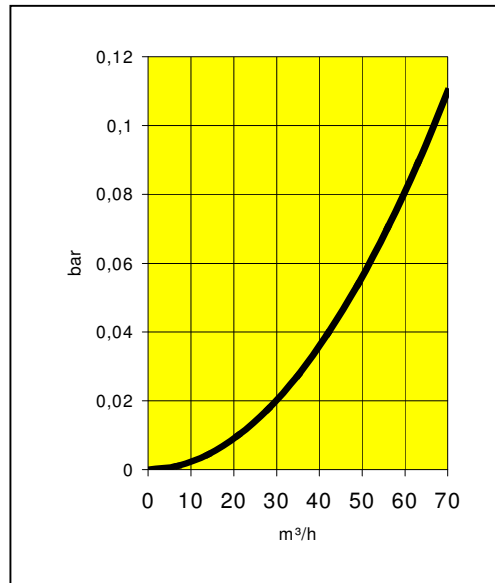
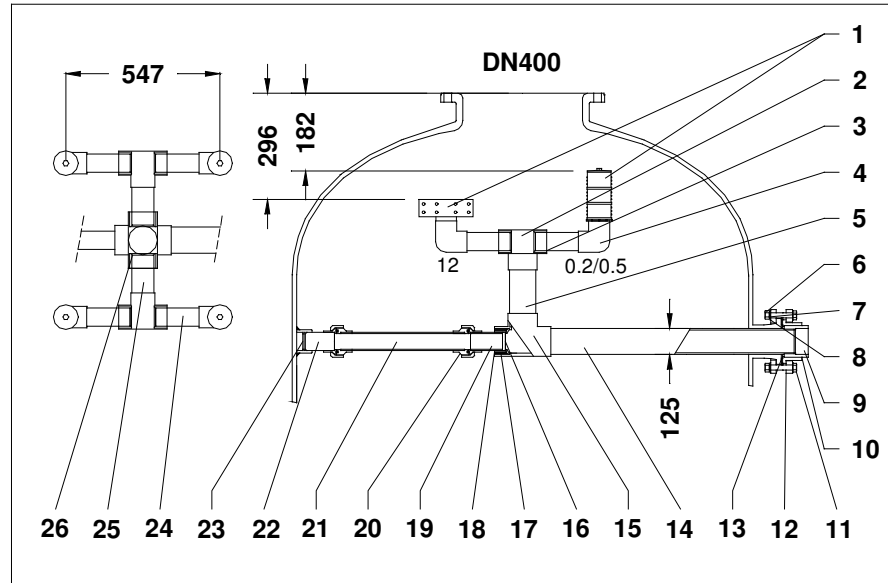
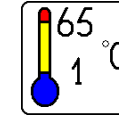

Technical specifications and icons for the resin collector system, including a circular arrow icon, three filter icons labeled ++0.2, ++0.5, and ++12, and a warning icon.

Item Position Article	Description Bezeichnung Description	Dimensions Dimensionen Dimensions	Quantity Menge Quantité	Material Material Matière	Part-Number Artikelnummer N° d' article		
1	Stack diffuser - Harzfänger - Collecteur de resine	2"	4	PP/PVC	A-2721-80	A-2600-65	G-1545-98
2	Tee - T-Stück - Té	90	2	PVC	A-2010-90	A-2010-90	A-2010-90
3	Reduction - Reduzierung - Réduction	90-63	4	PVC	A-3050-91	A-3050-91	A-3050-91
4	Elbow - Winkel - Coude	63 - 2"	4	PVC	A-2350-63	A-2350-63	A-2350-63
5	Pipe PN10 - Rohr PN10 - Tube PN10	125	165mm	PVC	A-PIPE-125	A-PIPE-125	A-PIPE-125
6	Nut - Mutter - Ecrou	M20	8	SS	A-M20-A4	A-M20-A4	A-M20-A4
7	Spring Washer - Federringe - Rondelle élastique	M20	8	SS	A-M20-VRO	A-M20-VRO	A-M20-VRO
8	Washer - Unterlegscheibe - Rondelle	M20	16	SS	A-M20-RON	A-M20-RON	A-M20-RON
9	Adapter Socket - Schraubmuffe - Manchon taraudé	4.5" - 125	1	PVC	A-3101-60	A-3101-60	A-3101-60
10	Collar - Bundbuchse - Collet	160	1	PVC	A-3721-61	A-3721-61	A-3721-61
11	Bolt - Bolz - Boulon	M20 x 120	8	SS	A-M20-120	A-M20-120	A-M20-120
12	Flange - Flansch - Bride	DN150	1	PVC	A-3721-60	A-3721-60	A-3721-60
13	Flat seal - Dichtung - Joint	DN150	1	NBR	A-2600-150	A-2600-150	A-2600-150
...	Continued on page 2 - Fortzetsung auf Zeite 2 - Continuation sur page 2	...	...	...	...	...	...

Pour tous système de distribution spécial, nous consulter

48"

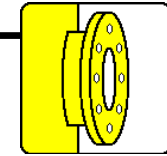

DN150

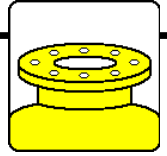

DN400



Item Position Article	Description Bezeichnung Description	Dimensions Dimensionen Dimensions	Quantity Menge Quantité	Material Material Matière	Part-Number Artikelnummer N°. d' article		
...	Continued from page 1 - Fortzsetzung von Zeite 1 - Continuation de page 1	...	...	...	...	...	...
14	Pipe PN16 - Rohr PN16 - Tube PN16	125 - 4.5" - 737	1	PVC	A-PVC7-125	A-PVC7-125	A-PVC7-125
15	Tee - T-Stück - Té	125	2	PVC	A-2011-25	A-2011-25	A-2011-25
16	Disk - Scheibe - Disque	63	1	PVC	A-DISK-63	A-DISK-63	A-DISK-63
17	Reduction - Reduzierung - Réduction	90 - 63	1	PVC	A-3050-91	A-3050-91	A-3050-91
18	Reduction - Reduzierung - Réduction	125 - 90	1	PVC	A-3051-26	A-3051-26	A-3051-26
19	Pipe PN10 - Rohr PN10 - Tube PN10	63	100mm	PVC	G-19-2394	G-19-2394	G-19-2394
20	Adapter union - Verschraubung - Raccord union	63	2	PVC	A-3600-63	A-3600-63	A-3600-63
21	Pipe PN10 - Rohr PN10 - Tube PN10	63	217mm	PVC	G-19-2394	G-19-2394	G-19-2394
22	Support - Unterstützung - Appui	63 x 100	1	PVC	A-SUPVC-63	A-SUPVC-63	A-SUPVC-63
23	Support Socket - Unterstützungsmuffe - Machon d'appui	63	1	PE	A-SUPE-63	A-SUPE-63	A-SUPE-63
24	Pipe PN10 - Rohr PN10 - Tube PN10	63	192mm	PVC	G-19-2394	G-19-2394	G-19-2394
25	Pipe PN10 - Rohr PN10 - Tube PN10	90	155mm	PVC	A-PIPE-90	A-PIPE-90	A-PIPE-90
26	Reduction - Reduzierung - Réduction	125 - 90	2	PVC	A-3051-26	A-3051-26	A-3051-26

A-UP12548-02	A-UP12548-05	A-UP12548-12
--------------	--------------	--------------

Pour tous système de distribution spécial, nous consulter

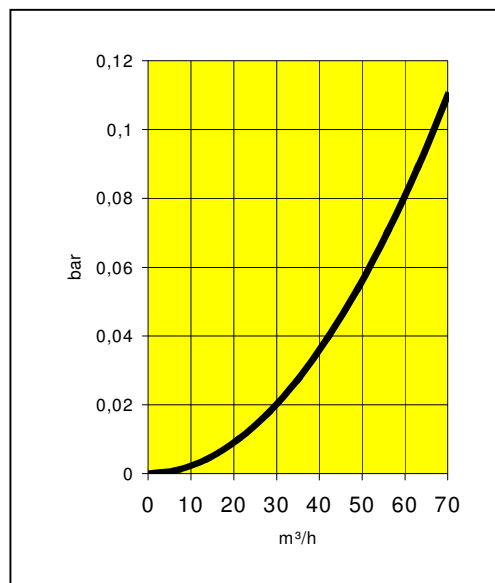
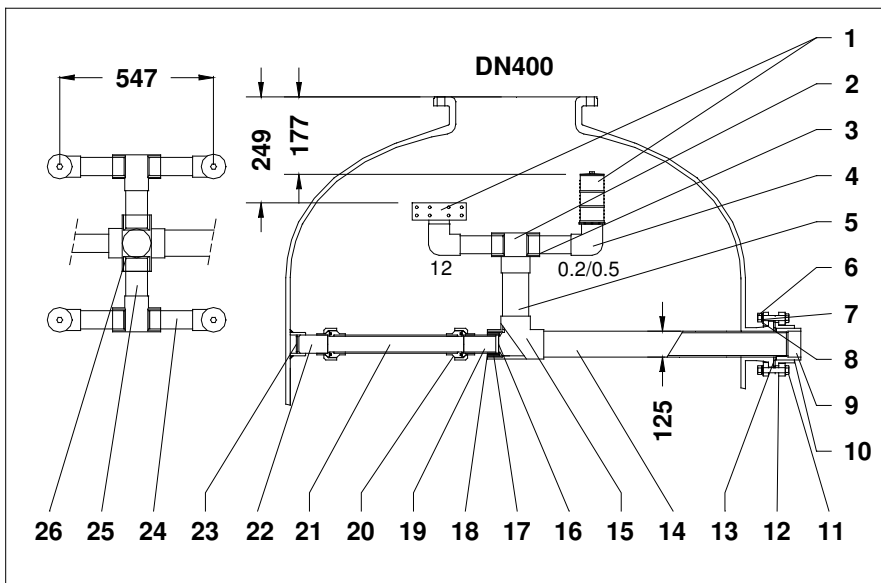

55"

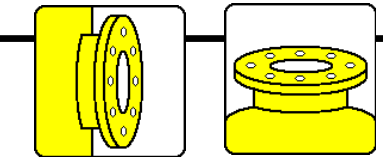

DN150

DN400

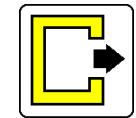
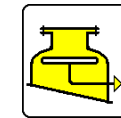
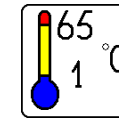

125 mm

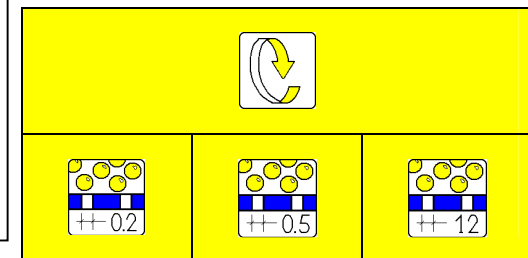

Item Position Article	Description Bezeichnung Description	Dimensions Dimensionen Dimensions	Quantity Menge Quantité	Material Material Matière	Part-Number Artikelnummer N° d' article		
1	Stack diffuser - Harzfänger - Collecteur de resine	2"	4	PP/PVC	A-2721-80	A-2600-65	G-1545-98
2	Tee - T-Stück - Té	90	2	PVC	A-2010-90	A-2010-90	A-2010-90
3	Reduction - Reduzierung - Réduction	90-63	4	PVC	A-3050-91	A-3050-91	A-3050-91
4	Elbow - Winkel - Coude	63 - 2"	4	PVC	A-2350-63	A-2350-63	A-2350-63
5	Pipe PN10 - Rohr PN10 - Tube PN10	125	175mm	PVC	A-PIPE-125	A-PIPE-125	A-PIPE-125
6	Nut - Mutter - Ecrou	M20	8	SS	A-M20-A4	A-M20-A4	A-M20-A4
7	Spring Washer - Federringe - Rondelle élastique	M20	8	SS	A-M20-VRO	A-M20-VRO	A-M20-VRO
8	Washer - Unterlegscheibe - Rondelle	M20	16	SS	A-M20-RON	A-M20-RON	A-M20-RON
9	Adapter Socket - Schraubmuffe - Manchon taraudé	4.5" - 125	1	PVC	A-3101-60	A-3101-60	A-3101-60
10	Collar - Bundbuchse - Collet	160	1	PVC	A-3721-61	A-3721-61	A-3721-61
11	Bolt - Bolz - Boulon	M20 x 120	8	SS	A-M20-120	A-M20-120	A-M20-120
12	Flange - Flansch - Bride	DN150	1	PVC	A-3721-60	A-3721-60	A-3721-60
13	Flat seal - Dichtung - Joint	DN150	1	NBR	A-2600-150	A-2600-150	A-2600-150
...	Continued on page 2 - Fortzetsung auf Zeite 2 - Continuation sur page 2	...	...	...	...	...	...

Pour tous système de distribution spécial, nous consulter



55"

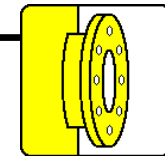

DN150

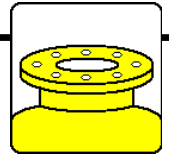

DN400

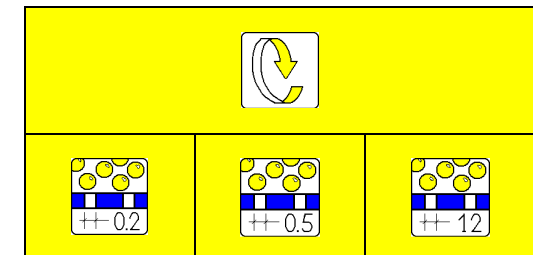

Item Position Article	Description Bezeichnung Description	Dimensions Dimensionen Dimensions	Quantity Menge Quantité	Material Material Matière	Part-Number Artikelnummer N°. d' article		
...	Continued from page 1 - Fortzsetzung von Zeite 1 - Continuation de page 1	...	...	...	...	...	...
14	Pipe PN16 - Rohr PN16 - Tube PN16	125 - 4.5" - 880	1	PVC	A-PVC8-125	A-PVC8-125	A-PVC8-125
15	Tee - T-Stück - Té	125	2	PVC	A-2011-25	A-2011-25	A-2011-25
16	Disk - Scheibe - Disque	63	1	PVC	A-DISK-63	A-DISK-63	A-DISK-63
17	Reduction - Reduzierung - Réduction	90 - 63	1	PVC	A-3050-91	A-3050-91	A-3050-91
18	Reduction - Reduzierung - Réduction	125 - 90	1	PVC	A-3051-26	A-3051-26	A-3051-26
19	Pipe PN10 - Rohr PN10 - Tube PN10	63	100mm	PVC	G-19-2394	G-19-2394	G-19-2394
20	Adapter union - Verschraubung - Raccord union	63	2	PVC	A-3600-63	A-3600-63	A-3600-63
21	Pipe PN10 - Rohr PN10 - Tube PN10	63	312mm	PVC	G-19-2394	G-19-2394	G-19-2394
22	Support - Unterstützung - Appui	63 x 100	1	PVC	A-SUPVC-63	A-SUPVC-63	A-SUPVC-63
23	Support Socket - Unterstützungsmuffe - Machon d'appui	63	1	PE	A-SUPE-63	A-SUPE-63	A-SUPE-63
24	Pipe PN10 - Rohr PN10 - Tube PN10	63	192mm	PVC	G-19-2394	G-19-2394	G-19-2394
25	Pipe PN10 - Rohr PN10 - Tube PN10	90	155mm	PVC	A-PIPE-90	A-PIPE-90	A-PIPE-90
26	Reduction - Reduzierung - Réduction	125 - 90	2	PVC	A-3051-26	A-3051-26	A-3051-26

A-UP12555-02	A-UP12555-05	A-UP12555-12
--------------	--------------	--------------

Pour tous système de distribution spécial, nous consulter

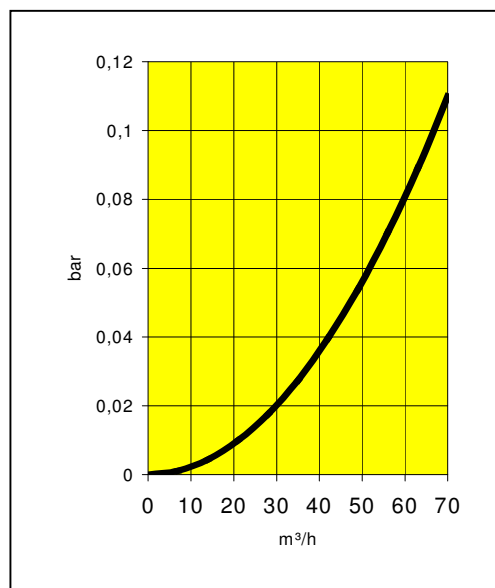
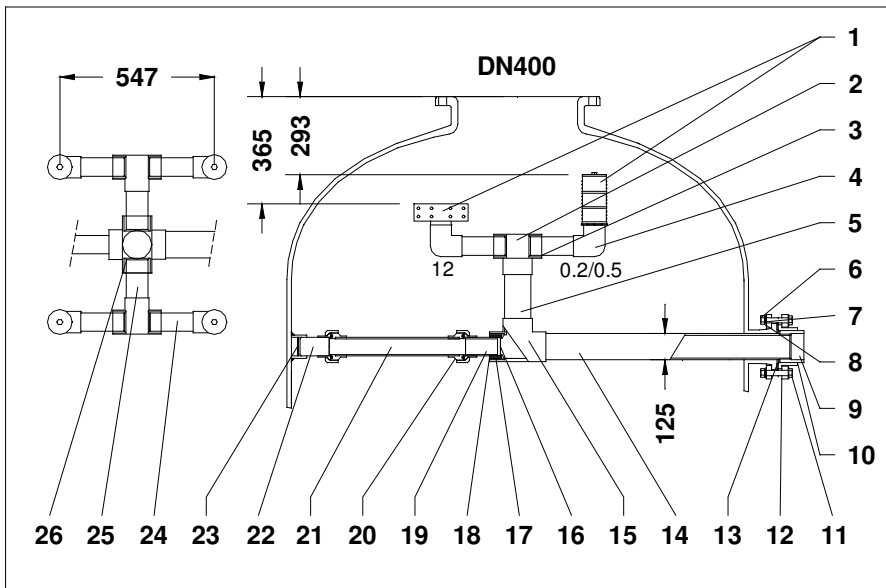

63"

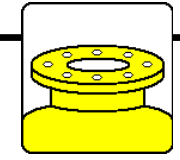
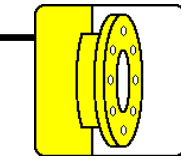

DN150

DN400

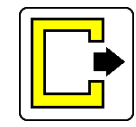
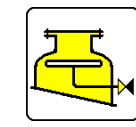
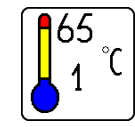

125 mm

±0.2

±0.5

±12

Item Position Article	Description Bezeichnung Description	Dimensions Dimensionen Dimensions	Quantity Menge Quantité	Material Material Matière	Part-Number Artikelnummer N° d' article		
1	Stack diffuser - Harzfänger - Collecteur de resine	2"	4	PP/PVC	A-2721-80	A-2600-65	G-1545-98
2	Tee - T-Stück - Té	90	2	PVC	A-2010-90	A-2010-90	A-2010-90
3	Reduction - Reduzierung - Réduction	90-63	4	PVC	A-3050-91	A-3050-91	A-3050-91
4	Elbow - Winkel - Coude	63 - 2"	4	PVC	A-2350-63	A-2350-63	A-2350-63
5	Pipe PN10 - Rohr PN10 - Tube PN10	125	221mm	PVC	A-PIPE-125	A-PIPE-125	A-PIPE-125
6	Nut - Mutter - Ecrou	M20	8	SS	A-M20-A4	A-M20-A4	A-M20-A4
7	Spring Washer - Federringe - Rondelle élastique	M20	8	SS	A-M20-VRO	A-M20-VRO	A-M20-VRO
8	Washer - Unterlegscheibe - Rondelle	M20	16	SS	A-M20-RON	A-M20-RON	A-M20-RON
9	Adapter Socket - Schraubmuffe - Manchon taraudé	4.5" - 125	1	PVC	A-3101-60	A-3101-60	A-3101-60
10	Collar - Bundbuchse - Collet	160	1	PVC	A-3721-61	A-3721-61	A-3721-61
11	Bolt - Bolz - Boulon	M20 x 120	8	SS	A-M20-120	A-M20-120	A-M20-120
12	Flange - Flansch - Bride	DN150	1	PVC	A-3721-60	A-3721-60	A-3721-60
13	Flat seal - Dichtung - Joint	DN150	1	NBR	A-2600-150	A-2600-150	A-2600-150
...	Continued on page 2 - Fortzetsung auf Zeite 2 - Continuation sur page 2	...	...	...	...	...	...

Pour tous système de distribution spécial, nous consulter

63"

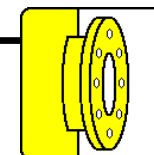

DN150

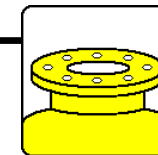

DN400



Item Position Article	Description Bezeichnung Description	Dimensions Dimensionen Dimensions	Quantity Menge Quantité	Material Material Matière	Part-Number Artikelnummer N°. d' article		
...	<i>Continued from page 1 - Fortzetsung von Zeile 1 - Continuation de page 1</i>	...	...	...	...	...	...
14	Pipe PN16 - Rohr PN16 - Tube PN16	125 - 4.5" - 960	1	PVC	A-PVC9-125	A-PVC9-125	A-PVC9-125
15	Tee - T-Stück - Té	125	2	PVC	A-2011-25	A-2011-25	A-2011-25
16	Disk - Scheibe - Disque	63	1	PVC	A-DISK-63	A-DISK-63	A-DISK-63
17	Reduction - Reduzierung - Réduction	90 - 63	1	PVC	A-3050-91	A-3050-91	A-3050-91
18	Reduction - Reduzierung - Réduction	125 - 90	1	PVC	A-3051-26	A-3051-26	A-3051-26
19	Pipe PN10 - Rohr PN10 - Tube PN10	63	100mm	PVC	G-19-2394	G-19-2394	G-19-2394
20	Adapter union - Verschraubung - Raccord union	63	2	PVC	A-3600-63	A-3600-63	A-3600-63
21	Pipe PN10 - Rohr PN10 - Tube PN10	63	396mm	PVC	G-19-2394	G-19-2394	G-19-2394
22	Support - Unterstützung - Appui	63 x 100	1	PVC	A-SUPVC-63	A-SUPVC-63	A-SUPVC-63
23	Support Socket - Unterstützungsmuffe - Machon d'appui	63	1	PE	A-SUPE-63	A-SUPE-63	A-SUPE-63
24	Pipe PN10 - Rohr PN10 - Tube PN10	63	192mm	PVC	G-19-2394	G-19-2394	G-19-2394
25	Pipe PN10 - Rohr PN10 - Tube PN10	90	155mm	PVC	A-PIPE-90	A-PIPE-90	A-PIPE-90
26	Reduction - Reduzierung - Réduction	125 - 90	2	PVC	A-3051-26	A-3051-26	A-3051-26

A-UP12563-02

A-UP12563-05

A-UP12563-12

Pour tous système de distribution spécial, nous consulter

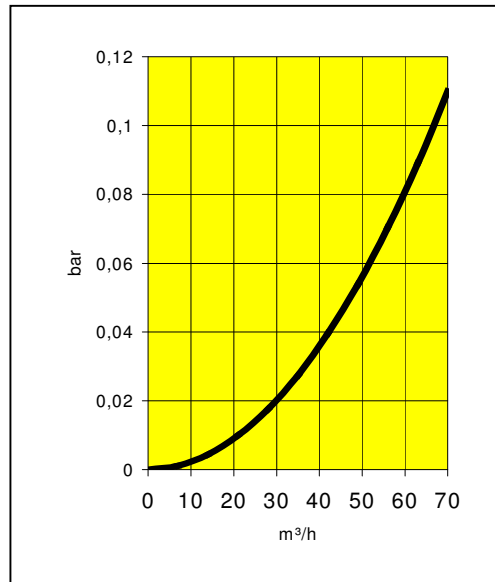
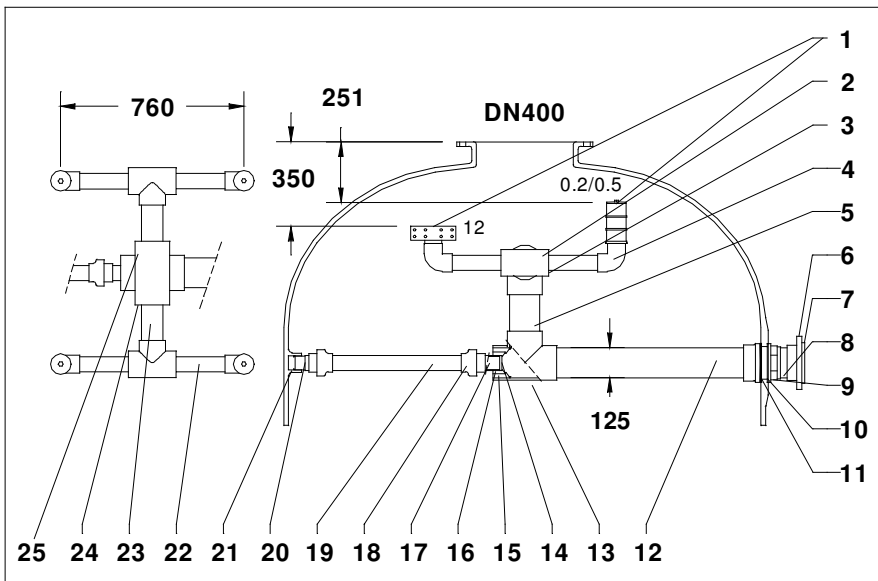

79"

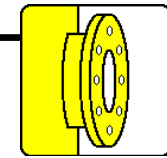

125mm

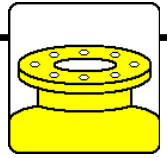

DN400

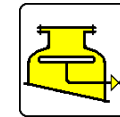
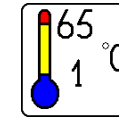

D125  
DN125

Recycling symbol

Pressure drop tolerance icons: ±0.2, ±0.5, ±1.2

Item Position Article	Description Bezeichnung Description	Dimensions Dimensionen Dimensions	Quantity Menge Quantité	Material Material Matière	Part-Number Artikelnummer N° d' article		
1	Stack diffuser - Harzfänger - Collecteur de resine	2"	4	PP/PVC	A-2721-80	A-2600-65	G-1545-98
2	Tee - T-Stück - Té	90	2	PVC	A-2010-90	A-2010-90	A-2010-90
3	Reduction - Reduzierung - Réduction	90-63	4	PVC	A-3050-91	A-3050-91	A-3050-91
4	Elbow - Winkel - Coude	63 - 2"	4	PVC	A-2350-63	A-2350-63	A-2350-63
5	Pipe PN10 - Rohr PN10 - Tube PN10	125	438mm	PVC	A-PIPE-125	A-PIPE-125	A-PIPE-125
6	Flange - Flansch - Bride	DN125	1	PP/GVK	X-1V-IP125	X-1V-IP125	X-1V-IP125
7	Collar - Bundbuchse - Collet	125	1	PVC	A-3721-30	A-3721-30	A-3721-30
8	Table duct - Durchführung - Traversée	125	1	PVC	A-DOOR-125	A-DOOR-125	A-DOOR-125
9	Nut - Mutter - Erou	M133	1	PVC	A-8111-10	A-8111-10	A-8111-10
10	Slipring - Gleitring - Joint à glisse	160	1	PVC	A-8081-10	A-8081-10	A-8081-10
11	Flat seal - Dichtung - Joint	160	1	NBR	A-8051-40	A-8051-40	A-8051-40
12	Pipe PN10 - Rohr PN10 - Tube PN10	125	894mm	PVC	A-PIPE-125	A-PIPE-125	A-PIPE-125
13	Tee - T-Stück - Té	125	1	PVC	A-2011-25	A-2011-25	A-2011-25
...	Continued on page 2 - Fortzetsung auf Zeite 2 - Continuation sur page 2	...	...	...	...	...	...

Pour tous système de distribution spécial, nous consulter

**STRUCTURAL**  
GROUP

79"

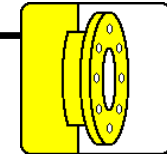

125mm

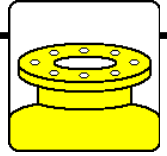

DN400



Item Position Article	Description Bezeichnung Description	Dimensions Dimensionen Dimensions	Quantity Menge Quantité	Material Material Matière	Part-Number Artikelnummer N°. d' article		
...	<i>Continued from page 1 - Fortzetsung von Zeile 1 - Continuation de page 1</i>	...	...	...	...	...	...
14	Disk - Scheibe - Disque	63	1	PVC	A-DISK-63	A-DISK-63	A-DISK-63
15	Reduction - Reduzierung - Réduction	125 - 90	1	PVC	A-3051-26	A-3051-26	A-3051-26
16	Reduction - Reduzierung - Réduction	90 - 63	1	PVC	A-3050-91	A-3050-91	A-3050-91
17	Pipe PN10 - Rohr PN10 - Tube PN10	63	100mm	PVC	G-19-2394	G-19-2394	G-19-2394
18	Adapter union - Verschraubung - Raccord union	63	2	PVC	A-3600-63	A-3600-63	A-3600-63
19	Pipe PN10 - Rohr PN10 - Tube PN10	63	613mm	PVC	G-19-2394	G-19-2394	G-19-2394
20	Support - Unterst�tzung - Appui	63 x 100	1	PVC	A-SUPVC-63	A-SUPVC-63	A-SUPVC-63
21	Support Socket - Unterst�tzungsmuffe - Machon d'appui	63	1	PE	A-SUPE-63	A-SUPE-63	A-SUPE-63
22	Pipe PN10 - Rohr PN10 - Tube PN10	63	279mm (4x)	PVC	G-19-2394	G-19-2394	G-19-2394
23	Pipe PN10 - Rohr PN10 - Tube PN10	90	250mm (2x)	PVC	A-PIPE-90	A-PIPE-90	A-PIPE-90
24	Reduction - Reduzierung - Réduction	125 - 90	2	PVC	A-3051-26	A-3051-26	A-3051-26
25	Tee - T-St�ck - T�	125	1	PVC	A-2011-25	A-2011-25	A-2011-25

I-UP12579-02

I-UP12579-05

I-UP12579-12

Pour tous syst me de distribution sp cial, nous consulter

**STRUCTURAL**  
 GROUP

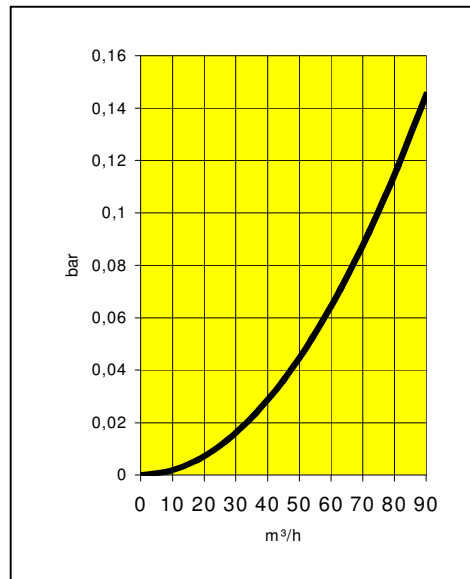
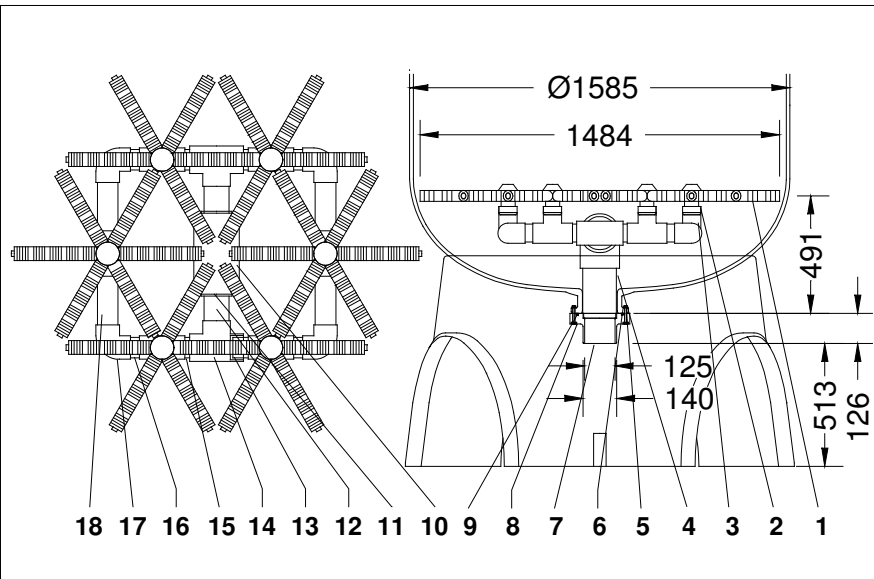

63"

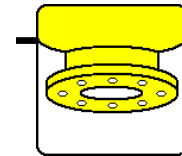

6" FLANGE

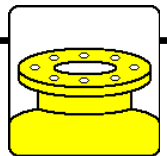

DN400

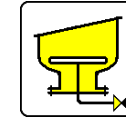
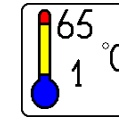

125/140 mm

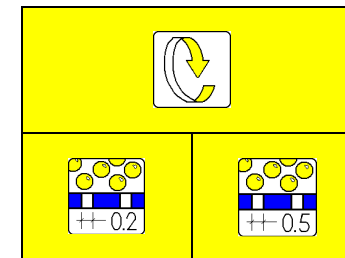

Item Position Article	Description Bezeichnung Description	Dimensions Dimensionen Dimensions	Quantity Menge Quantité	Material Material Matière	Part-Number Artikelnummer N° d'article	
1	Lateral hub system - Verteilerrohre & Verteilerkopfe - Latéraux & Distributeurs	Ø1484	1	PP	A-2600-64	A-2721-81
2	Adapter union - Verschraubung - Raccord union	Ø 63 - 2"	6	PVC	A-2600-63	A-2600-63
3	T-Reduction - T-Reduzierung - T-Réduction	Ø 75- Ø 63- Ø 75	6	PVC	A-1314-92	A-1314-92
4	Pipe PN16 - Rohr PN16 - Tube PN16	Ø140 x 284	1	PVC	A-PVC1-40	A-PVC1-40
5	Bolt - Bolzen - Boulon	M8 x 75	12	SS	A-8894-00	A-8894-00
6	Nut - Mutter - Ecrou	M8	12	SS	A-8894-20	A-8894-20
7	Adapter - Adapter - Adaptateur	6" - Ø125/ Ø140	1	SS	A-1361-40	A-1361-40
8	Washer - Unterlegscheibe - Rondelle	M8	24	SS	A-8894-10	A-8894-10
9	O-ring - Dichtungsring - Joint torique	Ø183.52 x Ø6.99	1	NBR	A-2694-8F	A-2694-8F
10	Tee - T-Stück - Té	Ø140- Ø140- Ø140	1	PVC	A-T901-40	A-T901-40
11	Reduction - Reduzierung - Réduction	Ø 140-90	2	PVC	A-1314-90	A-1314-90
12	Pipe PN10 - Rohr PN10 - Tube PN10	Ø90 x 199	2	PVC	A-PIPE-90	A-PIPE-90
13	Reduction - Reduzierung - Réduction	Ø 90- Ø 75	4	PVC	A-3050-92	A-3050-92
...	Continued on page 2 - Fortsetzung auf Zeite 2 - Continuation sur page 2	...	...	...	...	...

Pour tous système de distribution spécial, nous consulter

**STRUCTURAL**  
GROUP

63"

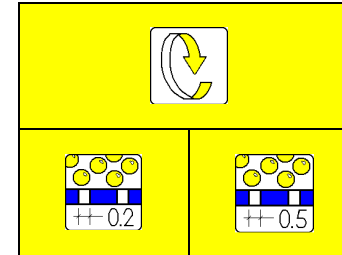
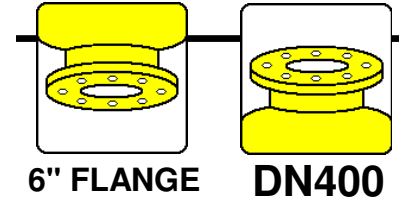

Item Position Article	Description Bezeichnung Description	Dimensions Dimensionen Dimensions	Quantity Menge Quantité	Material Material Matière	Part-Number Artikelnummer N° d'article	
...	<i>Continued from page 1 - Fortsetzung von Zeite 1 - Continuation de page 1</i>	...	...	...	...	...
14	Tee - T-Stück - Té	Ø 90- Ø 90- Ø 90	2	PVC	A-2010-90	A-2010-90
15	Pipe PN10 - Rohr PN10 - Tube PN10	Ø 75 x 105	4	PVC	A-PVC0-75	A-PVC0-75
16	Pipe PN10 - Rohr PN10 - Tube PN10	Ø 75 x 120	4	PVC	A-PVC0-75	A-PVC0-75
17	Elbow - Winkel - Coude	Ø 75	4	PVC	A-2700-75	A-2700-75
18	Pipe PN10 - Rohr PN10 - Tube PN10	Ø 75 x 265	4	PVC	A-PVC0-75	A-PVC0-75

I-LD63-02	I-LD63-05
-----------	-----------

Pour tous système de distribution spécial, nous consulter

**STRUCTURAL**  
GROUP

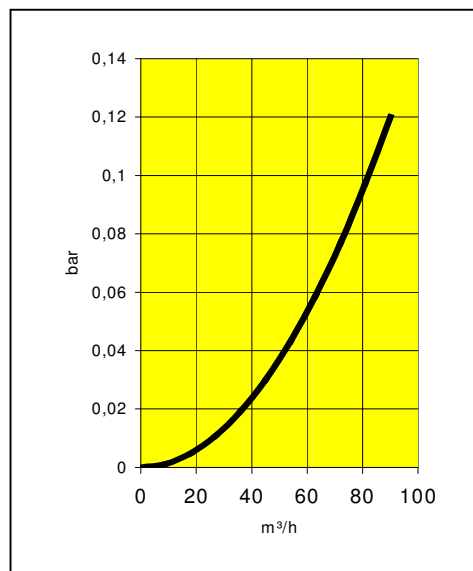
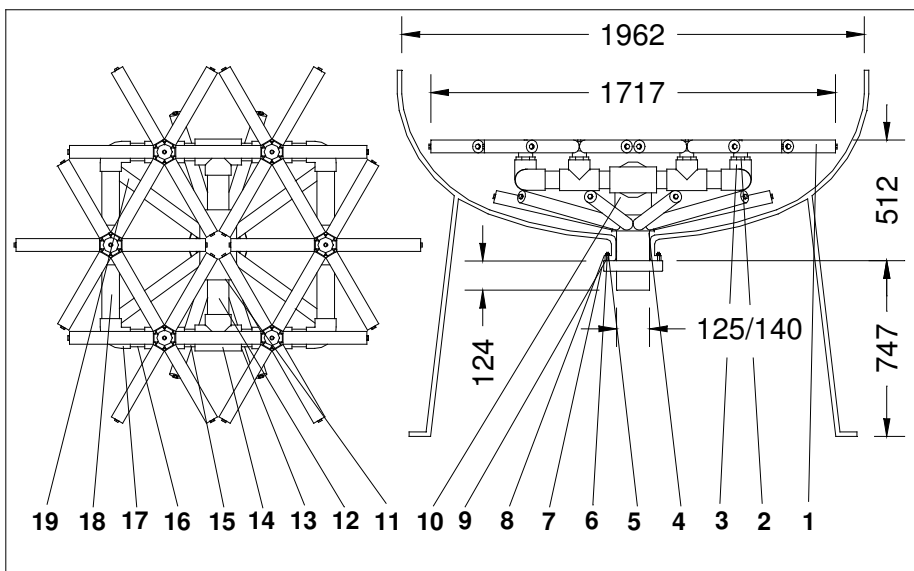

79"

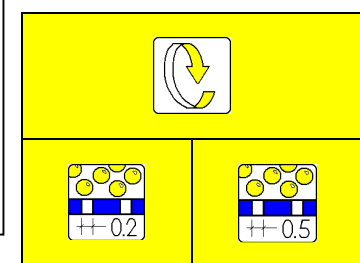
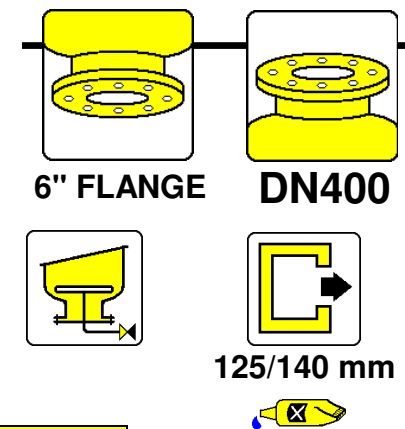

Item Position Article	Description Bezeichnung Description	Dimensions Dimensionen Dimensions	Quantity Menge Quantité	Material Material Matière	Part-Number Artikelnummer N°. d'article	
1	Lateral hub system - Verteilerrohre & Verteilerkopfe - Latéraux & Distributeurs	Ø1800	1	PP	A-SD602-1800	A-SD605-1800
2	Adapter union - Verschraubung - Raccord union	Ø 63 - 2"	6	PVC	A-2600-63	A-2600-63
3	T-Reduction - T-Reduzierung - T-Réduction	Ø 75 x 63 x 75	6	PVC	A-1314-92	A-1314-92
4	Riser tube/hub - Rorh/Verteilerkopf - Tube/Distributeur	Ø140 - 5"	1	PVC	A-RTHUB-79	A-RTHUB-79
5	Bolt - Bolzen - Boulon	M8 x 75	12	SS	A-M8-075	A-M8-075
6	Nut - Mutter - Ecrou	M8	12	SS	A-M8-A4	A-M8-A4
7	Adapter - Adapter - Adaptateur	6" - Ø125/ Ø140	1	PVC	A-1361-40	A-1361-40
8	Washer - Unterlegscheibe - Rondelle	M8	24	SS	A-M8-RON	A-M8-RON
9	O-ring - Dichtungsring - Joint torique	Ø183.52 x Ø6.99	1	NBR	A-2694-8F	A-2694-8F
10	Tee - T-Stück - Té	Ø140	1	PVC	A-T901-40	A-T901-40
11	Reduction - Reduzierung - Réduction	Ø 140-90	2	PVC	A-3051-90	A-3051-41
12	Pipe PN10 - Rohr PN10 - Tube PN10	Ø90 x 249	2	PVC	A-PIPE-90	A-PIPE-90
13	Reduction - Reduzierung - Réduction	Ø 90- Ø 75	4	PVC	A-3050-92	A-3050-92
...	Continued on page 2 - Fortzetsung auf Zeite 2 - Continuation sur page 2	...	...	...	...	...

Pour tous système de distribution spécial, nous consulter



79"

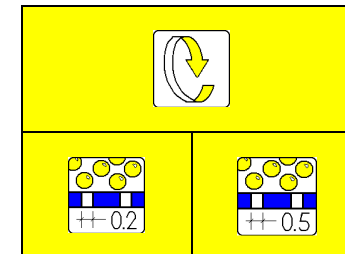
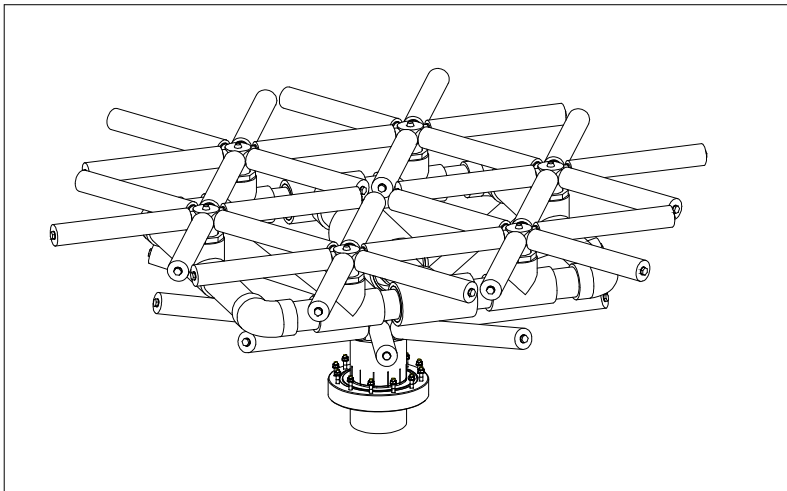
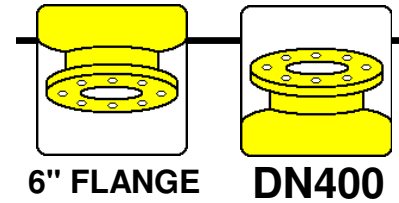

Item Position Article	Description Bezeichnung Description	Dimensions Dimensionen Dimensions	Quantity Menge Quantité	Material Material Matière	Part-Number Artikelnummer N°. d'article	
...	Continued from page 1 - Fortsetzung von Seite 1 - Continuation de page 1	...	...	...	...	...
14	Tee - T-Stück - Té	Ø 90	2	PVC	A-2010-90	A-2010-90
15	Pipe PN10 - Rohr PN10 - Tube PN10	Ø 75 x 133	4	PVC	A-PVC-075	A-PVC-075
16	Pipe PN10 - Rohr PN10 - Tube PN10	Ø 75 x 148	4	PVC	A-PVC-075	A-PVC-075
17	Elbow - Winkel - Coude	Ø 75	4	PVC	A-2700-75	A-2700-75
18	Pipe PN10 - Rohr PN10 - Tube PN10	Ø 75 x 316	4	PVC	A-PVC-075	A-PVC-075
19	Lateral - Verteilerrohr - Latéral	516 mm	10	PP	A-TH02-516	A-TH05-516

I-LD79-02	I-LD79-05
-----------	-----------

Pour tous système de distribution spécial, nous consulter

14" – 16" – 18"

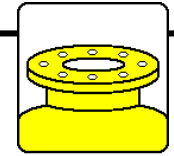

6" FLANGE

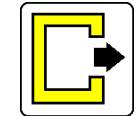
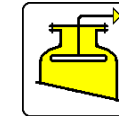
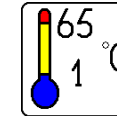
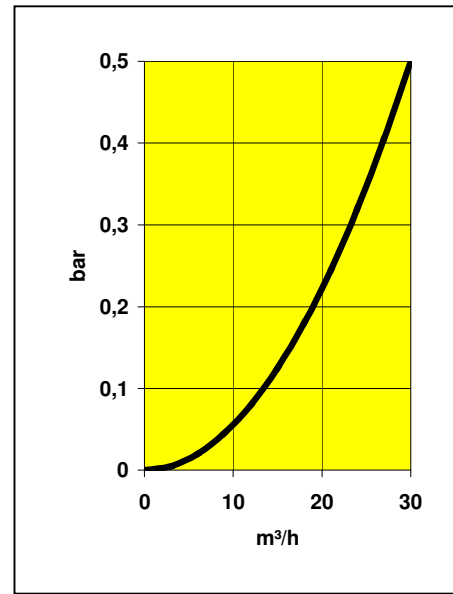
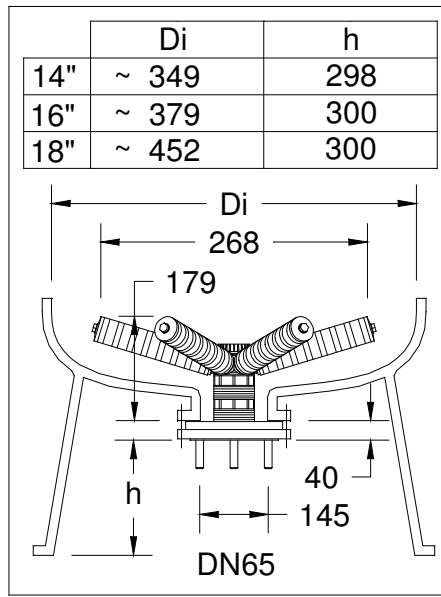
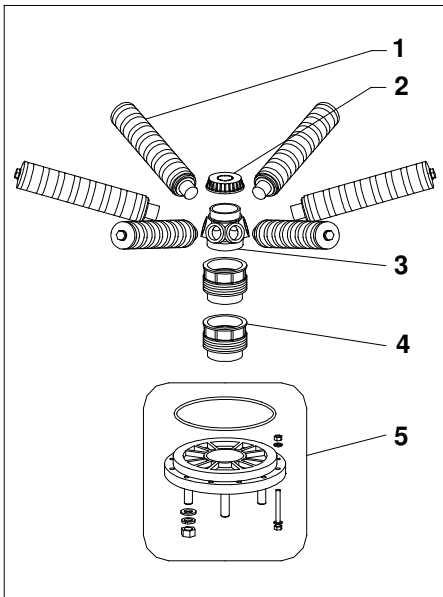

DN65

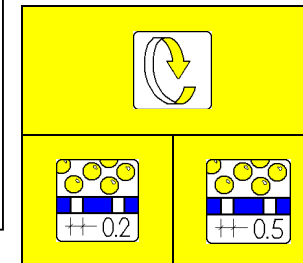

Item Position Article	Description Bezeichnung Description	Dimensions Dimensionen Dimensions	Quantity Menge Quantité	Material Material Matière	Part-Number Artikelnummer N° d' article	
1	Lateral – Verteilerrohr – Latéral	113 mm	6	PP	A-TH02-113	A-TH05-113
2	Hubcap – Verteilerkopfdeckel – Couvercle Distributeur	2" BSP	1	PP	AD-H60-00	AD-H60-00
3	Hub – Verteilerkopf – Distributeur	2.5"-2"	1	PP	ATD-H60-00	ATD-H60-00
4	Prolongation – Verlängerungsstück – Prolongation	2.5" – 50mm	2	PPO	A-3100-04C	A-3100-04C
5	Adaptor – Adapter – Adaptateur	6" – DN65	1	PPO	A-3100-02C	A-3100-02C



1

A-2716-F6	A-2516-F6
-----------	-----------

Pour tous système de distribution spécial, nous consulter

21" - 24"

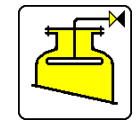
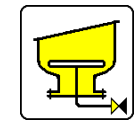
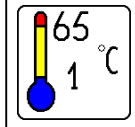
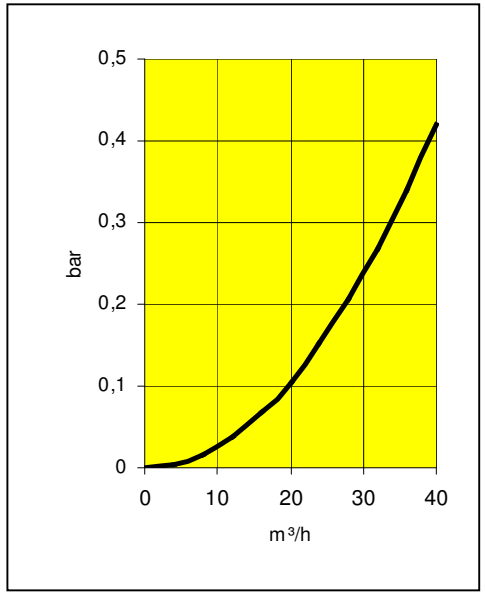
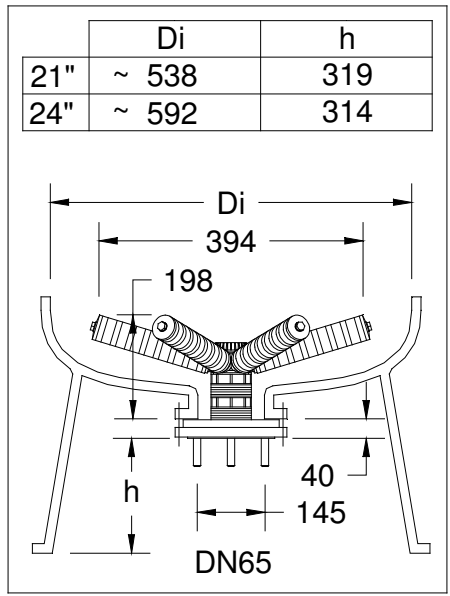
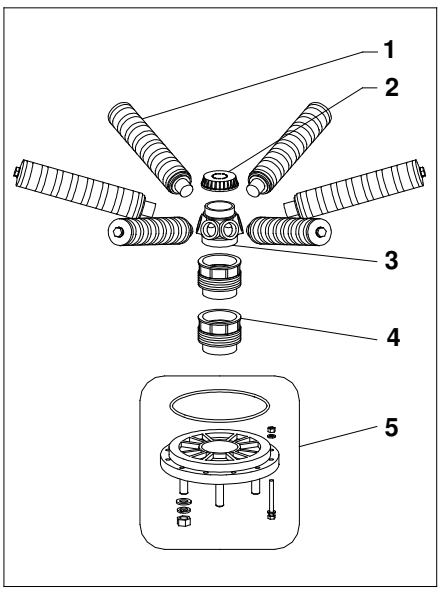
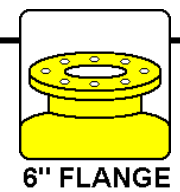

Item Position Article	Description Bezeichnung Description	Dimensions Dimensionen Dimensions	Quantity Menge Quantité	Material Material Matière	Part-Number Artikelnummer N°. article	
1	Lateral – Verteilerrohr – Latéral	175 mm	6	PP	A-TH02-175	A-TH05-175
2	Hubcap – Verteilerkopfdeckel – Couvercle Distributeur	2" BSP	1	PP	AD-H60-00	AD-H60-00
3	Hub – Verteilerkopf – Distributeur	2.5"-2"	1	PP	ATD-H60-00	ATD-H60-00
4	Prolongation – Verlängerungsstück – Prolongation	2.5" – 50mm	2	PPO	A-3100-04C	A-3100-04C
5	Adaptor – Adapter – Adaptateur	6" – DN65	1	PPO	A-3100-02C	A-3100-02C
					<b>A-2721-F6</b>	<b>A-2521-F6</b>



Pour tous système de distribution spécial, nous consulter

30''

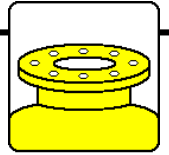

6" FLANGE

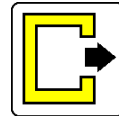
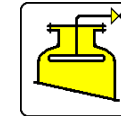
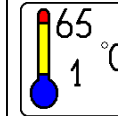
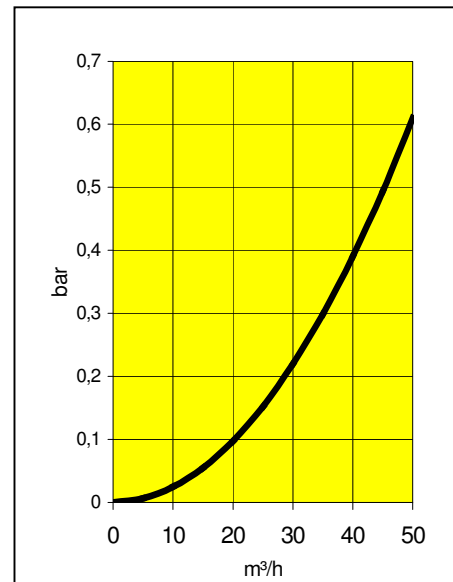
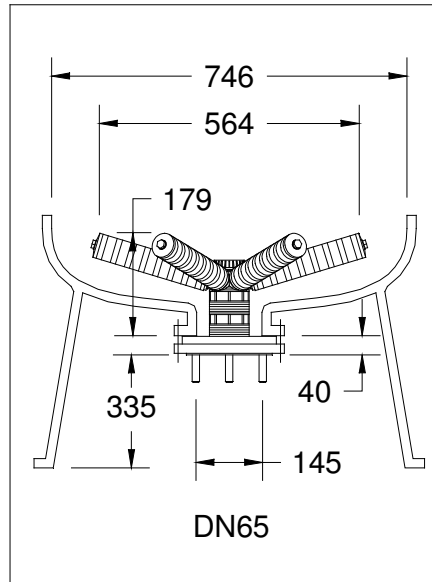
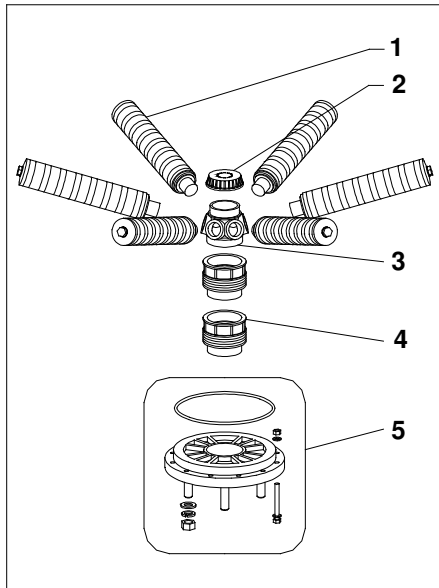

DN65

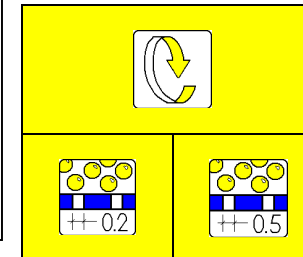

Item Position Article	Description Bezeichnung Description	Dimensions Dimensionen Dimensions	Quantity Menge Quantité	Material Material Matière	Part-Number Artikelnummer N°. d' article	
1	Lateral – Verteilerrohr – Latéral	268 mm	6	PP	A-TH02-268	A-TH05-268
2	Hubcap – Verteilerkopfdeckel – Couvercle Distributeur	2" BSP	1	PP	AD-H60-00	AD-H60-00
3	Hub – Verteilerkopf – Distributeur	2.5"-2"	1	PP	ATD-H60-00	ATD-H60-00
4	Prolongation – Verlängerungsstück – Prolongation	2.5" – 50mm	2	PPO	A-3100-04C	A-3100-04C
5	Adaptor – Adapter – Adaptateur	6" – DN65	1	PPO	A-3100-02C	A-3100-02C



1

A-2730-F6	A-2530-F6
-----------	-----------

Pour tous système de distribution spécial, nous consulter

36''

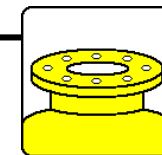

6" FLANGE

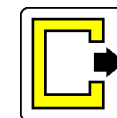
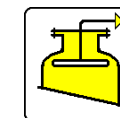
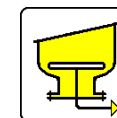
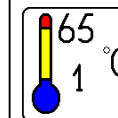
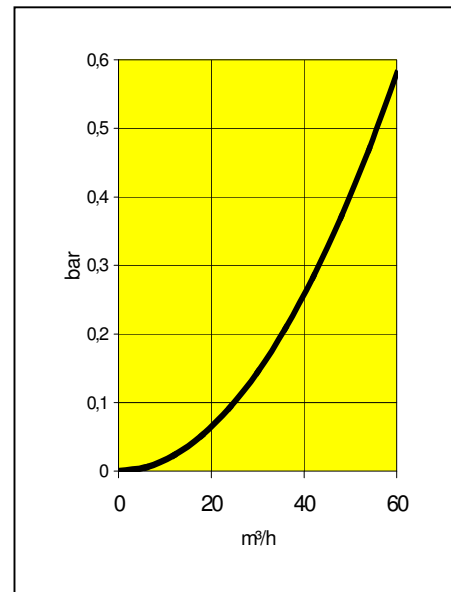
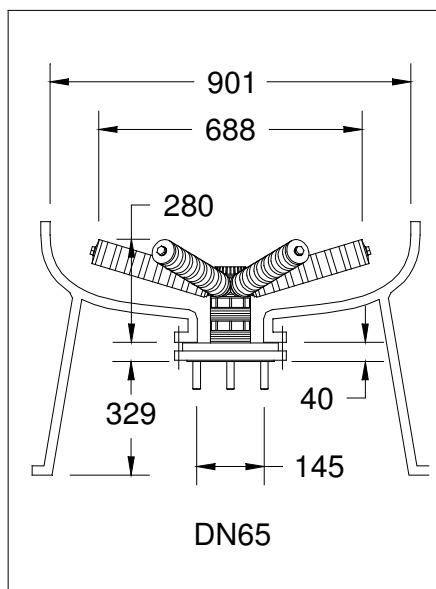
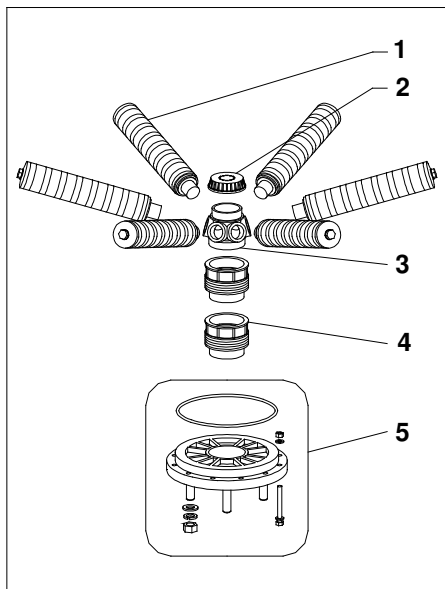

DN65

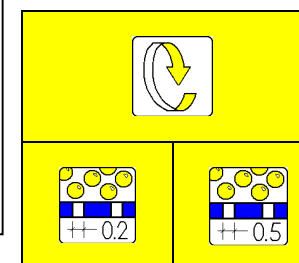

Item Position Article	Description Bezeichnung Description	Dimensions Dimensionen Dimensions	Quantity Menge Quantité	Material Material Matière	Part-Number Artikelnummer N° d' article	
1	Lateral – Verteilerrohr – Latéral	330 mm	6	PP	A-TH02-330	A-TH05-330
2	Hubcap – Verteilerkopfdeckel – Couvercle Distributeur	2" BSP	1	PP	AD-H60-00	AD-H60-00
3	Hub – Verteilerkopf – Distributeur	2.5"-2"	1	PP	ATD-H60-00	ATD-H60-00
4	Prolongation – Verlängerungsstück – Prolongation	2.5" – 50mm	2	PPO	A-3100-04C	A-3100-04C
5	Adaptor – Adapter – Adaptateur	6" – DN65	1	PPO	A-3100-02C	A-3100-02C



1

A-2736-F6	A-2536-F6
-----------	-----------

Pour tous système de distribution spécial, nous consulter

14" ... 36"

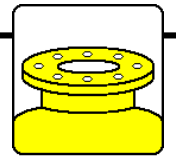
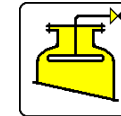
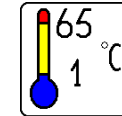
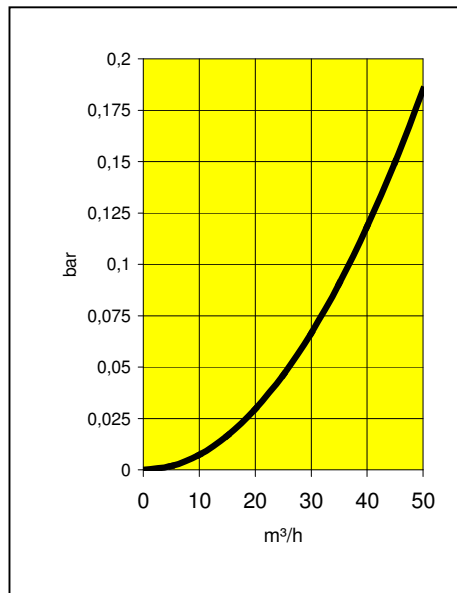
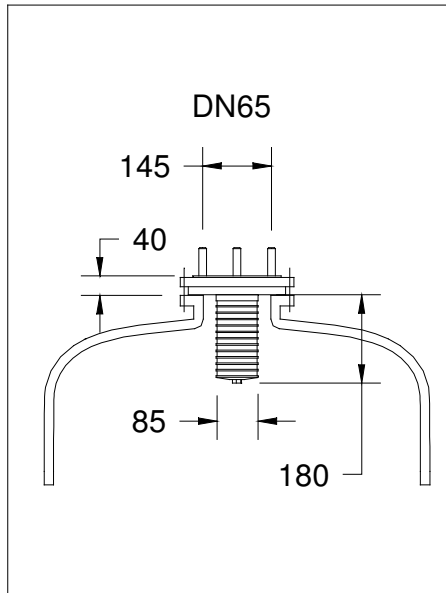
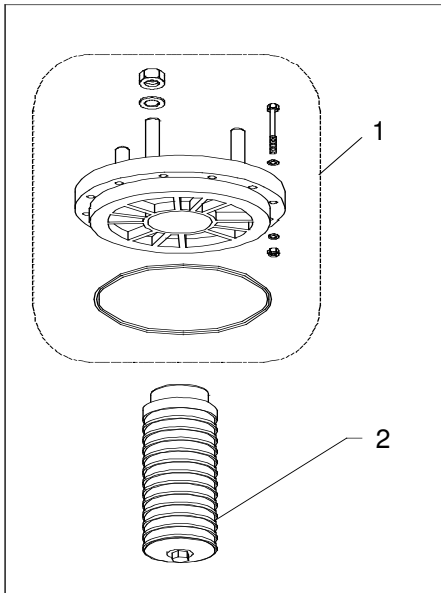

6" FLANGE

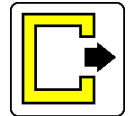

DN65

**A-2727-F6**    **A-2527-F6**

Item Position Article	Description Bezeichnung Description	Dimensions Dimensionen Dimensions	Quantity Menge Quantité	Material Material Matière	Part-Number Artikelnummer N° d' article	
1	Adaptor – Adapter – Adaptateur	6" - DN65	1	PPO	A-3100-02C	A-3100-02C
2	Diffusor – Harzfänger – Diffuseur	2.5" – 180mm	1	PP	A-2740--	A-2746--



1

Pour tous système de distribution spécial, nous consulter

42''

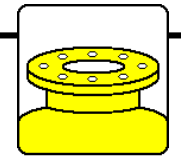

6" FLANGE

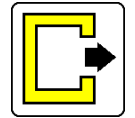
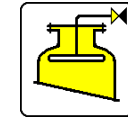
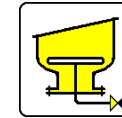
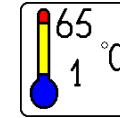

DN80

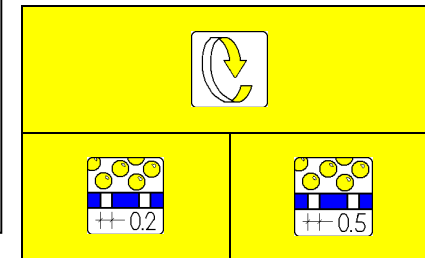
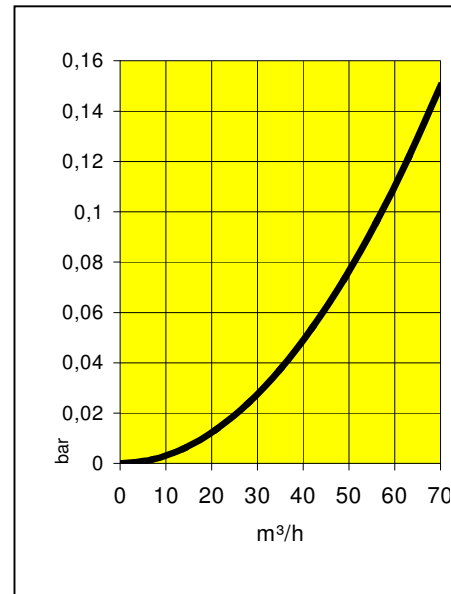
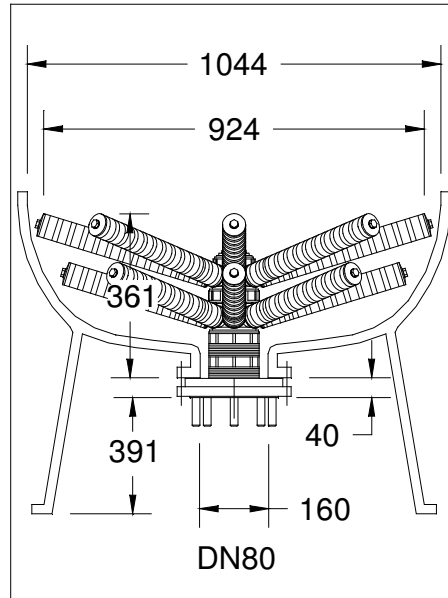
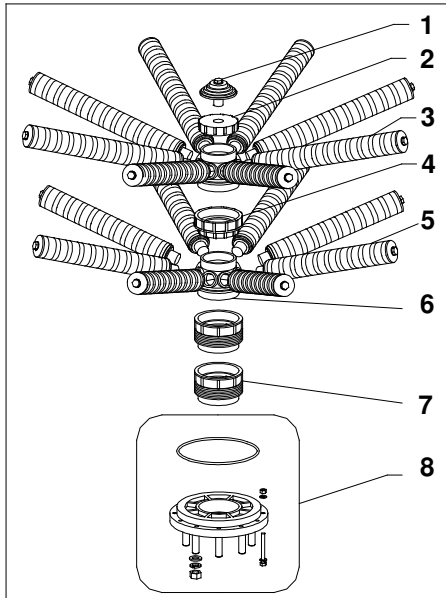

Item Position Article	Description Bezeichnung Description	Dimensions Dimensionen Dimensions	Quantity Menge Quantité	Material Material Matière	Part-Number Artikelnummer N° d' article	
1	Filter Nozzle – Filter Duse - Bouchon Crépine	3 / 4"	1	PP	A-2727-10	A-2727-10
2	Hubcap – Verteilerkopfdeckel – Couvercle Distributeur	3" BSP	1	PP	A-BTC8-30	A-BTC8-30
3	Lateral – Verteilerrohr – Latéral	423 mm	8	PP	A-TH02-423	A-TH05-423
4	Connection – Anschluss -Connection	3" – 4"	1	PP	AB-C08-40	AB-C08-40
5	Lateral – Verteilerrohr – Latéral	361 mm	8	PP	A-TH02-361	A-TH05-361
6	Hub – Verteilerkopf – Distributeur	4" – 3"	2	PP	ATD-H80-00	ATD-H80-00
7	Prolongation – Verlängerungsstück – Prolongation	4" – 50mm	2	PPO	A-3100-05C	A-3100-05C
8	Adaptor – Adapter – Adaptateur	6" – DN80	1	PPO	A-3100-03C	A-3100-03C



1

<b>A-2742-FL</b>	<b>A-2542-FL</b>
------------------	------------------

Pour tous système de distribution spécial, nous consulter

48''

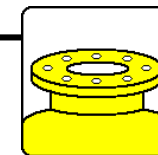

6" FLANGE

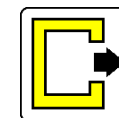
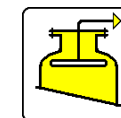
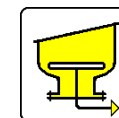
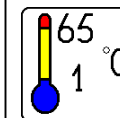
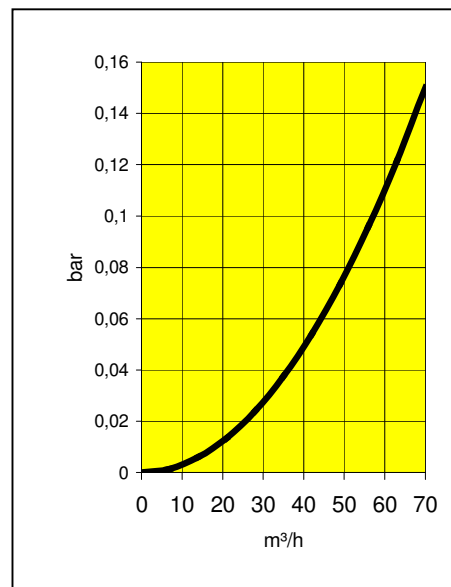
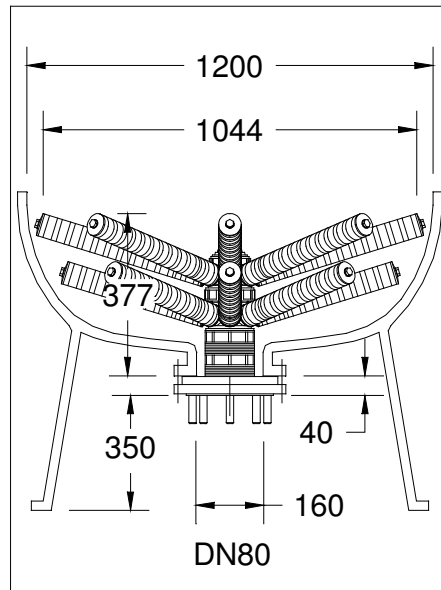
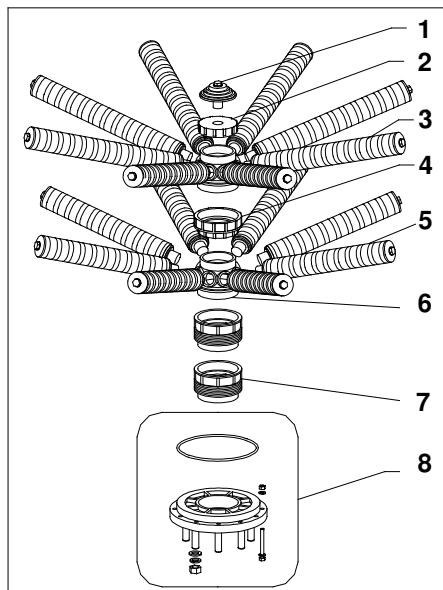

DN80

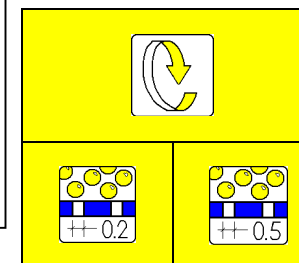

Item Position Article	Description Bezeichnung Description	Dimensions Dimensionen Dimensions	Quantity Menge Quantité	Material Material Matière	Part-Number Artikelnummer N° d' article	
1	Filter Nozzle – Filter Duse - Bouchon Crépine	3 / 4"	1	PP	A-2727-10	A-2727-10
2	Hubcap – Verteilerkopfdeckel – Couvercle Distributeur	3" BSP	1	PP	A-BTC8-30	A-BTC8-30
3	Lateral – Verteilerrohr – Latéral	485 mm	8	PP	A-TH02-485	A-TH05-485
4	Connection – Anschluss -Connection	3" – 4"	1	PP	AB-C08-40	AB-C08-40
5	Lateral – Verteilerrohr – Latéral	423 mm	8	PP	A-TH02-423	A-TH05-423
6	Hub – Verteilerkopf – Distributeur	4" – 3"	2	PP	ATD-H80-00	ATD-H80-00
7	Prolongation – Verlängerungsstück – Prolongation	4" – 50mm	2	PPO	A-3100-05C	A-3100-05C
8	Adaptor – Adapter – Adaptateur	6" – DN80	1	PPO	A-3100-03C	A-3100-03C



1

<b>A-2748-FL</b>	<b>A-2548-FL</b>
------------------	------------------

Pour tous système de distribution spécial, nous consulter



55''

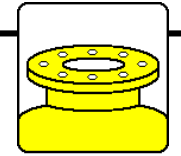

6" FLANGE

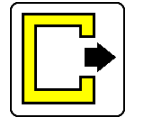
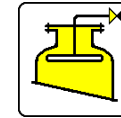
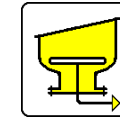
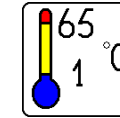
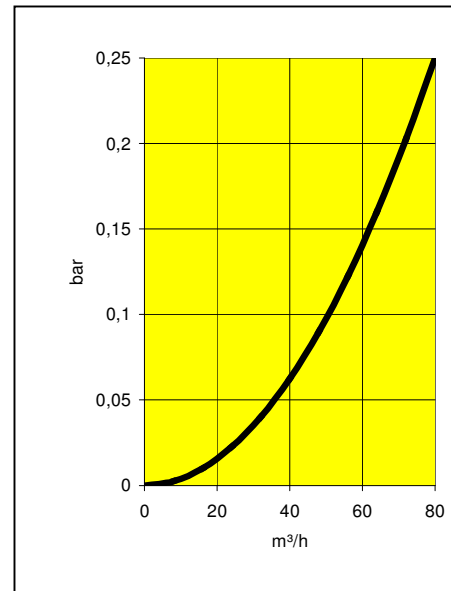
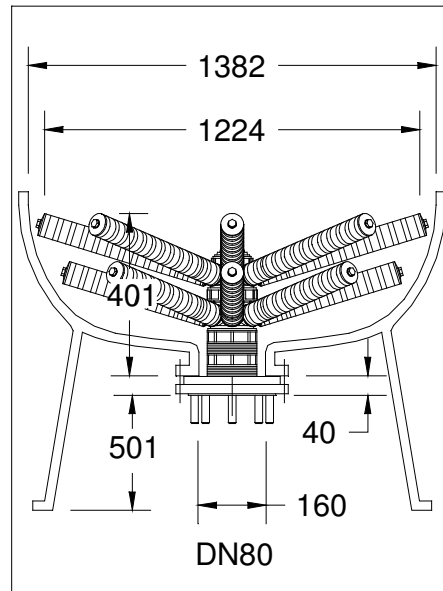
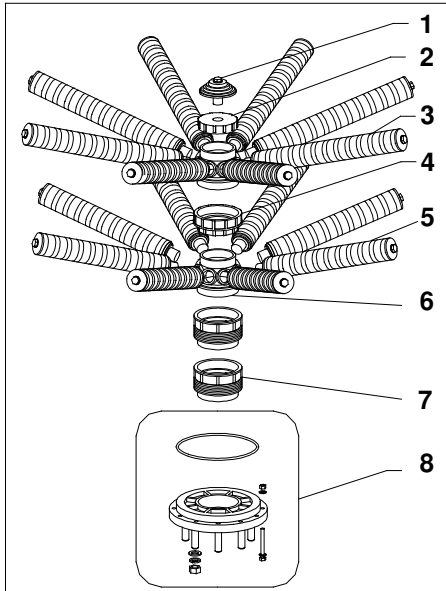

DN80

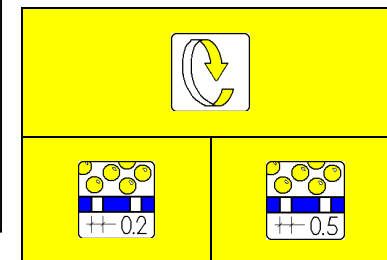

Item Position Article	Description Bezeichnung Description	Dimensions Dimensionen Dimensions	Quantity Menge Quantité	Material Material Matière	Part-Number Artikelnummer N°. d' article	
1	Filter Nozzle – Filter Duse - Bouchon Crépine	3 / 4"	1	PP	A-2727-10	A-2727-10
2	Hubcap – Verteilerkopfdeckel – Couvercle Distributeur	3" BSP	1	PP	A-BTC8-30	A-BTC8-30
3	Lateral – Verteilerrohr – Latéral	578 mm	8	PP	A-TH02-578	A-TH05-578
4	Connection – Anschluss -Connection	3" – 4"	1	PP	AB-C08-40	AB-C08-40
5	Lateral – Verteilerrohr – Latéral	516 mm	8	PP	A-TH02-516	A-TH05-516
6	Hub – Verteilerkopf – Distributeur	4" – 3"	2	PP	ATD-H80-00	ATD-H80-00
7	Prolongation – Verlängerungsstück – Prolongation	4" – 50mm	2	PPO	A-3100-05C	A-3100-05C
8	Adaptor – Adapter – Adaptateur	6" – DN80	1	PPO	A-3100-03C	A-3100-03C



A-2755-FL

A-2555-FL

Pour tous système de distribution spécial, nous consulter

63''

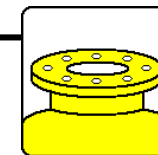

6" FLANGE

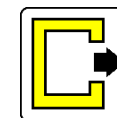
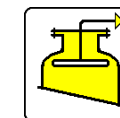
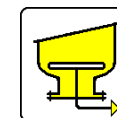
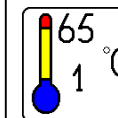
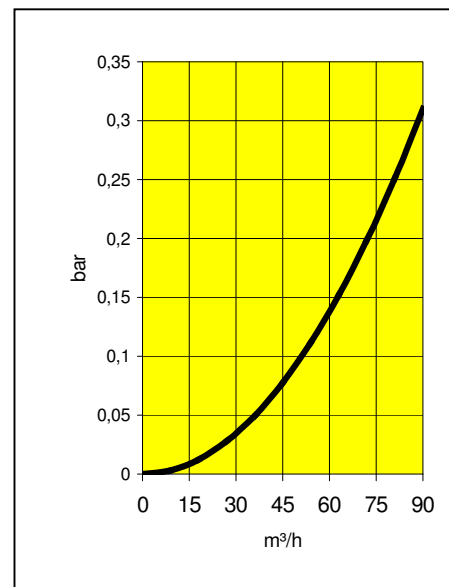
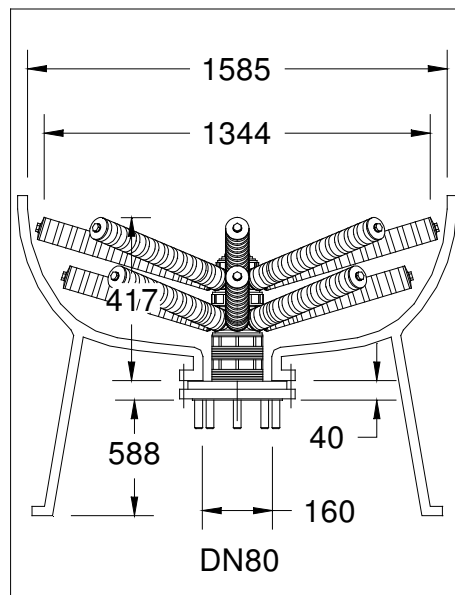
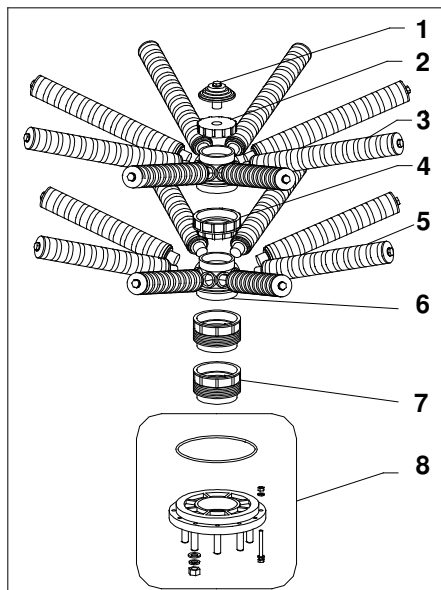

DN80

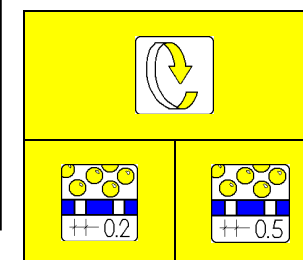

Item Position Article	Identification Bezeichnung Description	Dimensions Dimensionen Dimensions	Quantity Menge Quantité	Material Material Matière	Part-Number Artikelnummer N° d' article	
1	Filter Nozzle – Filter Duse - Boucon Crépine	3 / 4"	1	PP	A-2727-10	A-2727-10
2	Hubcap – Verteilerkopfdeckel – Couvercle Distributeur	3" BSP	1	PP	A-BTC8-30	A-BTC8-30
3	Lateral – Verteilerrohr – Latéral	640 mm	8	PP	A-TH02-640	A-TH05-640
4	Connection – Anschluss -Connection	3" – 4"	1	PP	AB-C08-40	AB-C08-40
5	Lateral – Verteilerrohr – Latéral	578 mm	8	PP	A-TH02-578	A-TH05-578
6	Hub – Verteilerkopf – Distributeur	4" – 3"	2	PP	ATD-H80-00	ATD-H80-00
7	Prolongation – Verlängerungsstück – Prolongation	4" – 50mm	2	PPO	A-3100-05C	A-3100-05C
8	Adaptor – Adapter – Adaptateur	6" – DN80	1	PPO	A-3100-03C	A-3100-03C



1

A-2763-FL	A-2563-FL
-----------	-----------

Pour tous système de distribution spécial, nous consulter

42"

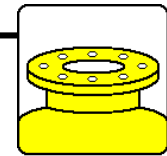
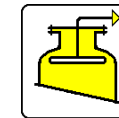
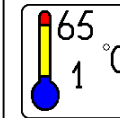
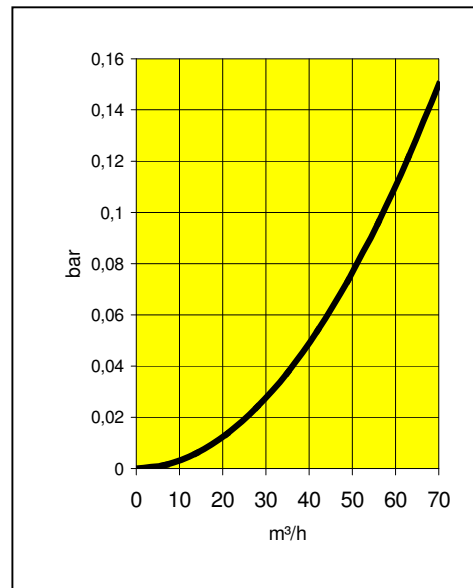
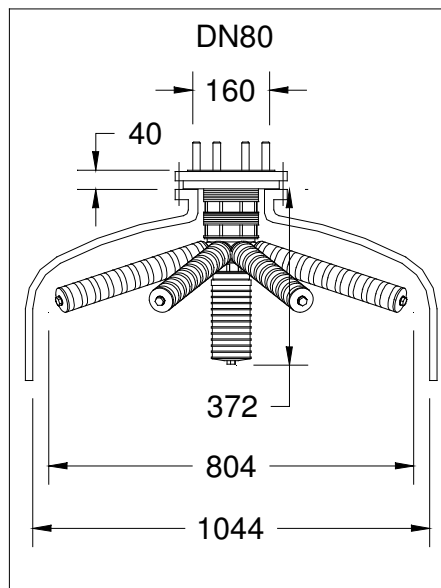
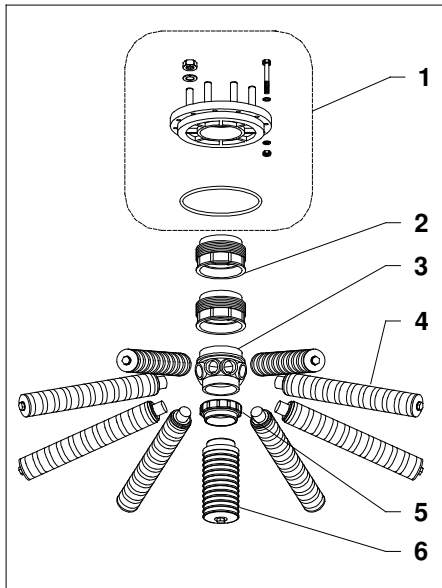

6" FLANGE

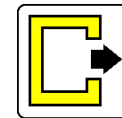

DN80

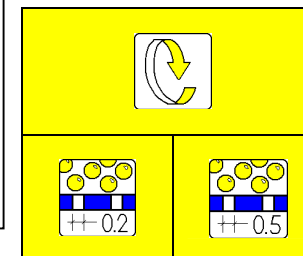

Item Position Article	Description Bezeichnung Description	Dimensions Dimensionen Dimensions	Quantity Menge Quantité	Material Material Matière	Part-Number Artikelnummer N° d' article	
1	Adaptor – Adapter – Adaptateur	6" – DN80	1	PPO	A-3100-03C	A-3100-03C
2	Prolongation – Verlängerungsstück – Prolongation	4" – 50mm	2	PPO	A-3100-05C	A-3100-05C
3	Hub – Verteilerkopf – Distributeur	4" – 3"	1	PP	ATD-H80-00	ATD-H80-00
4	Lateral – Verteilerrohr - Latéral	361 mm	8	PP	A-TH02-361	A-TH05-361
5	Connection – Anschluss - Connection	3" – 2.5"	1	PP	AB-C08-30	AB-C08-30
6	Diffusor – Harzfänger – Diffuseur	2.5" – 180 mm	1	PP	A-2740--	A-2746--



1

A-2742-FU	A-2542-FU
-----------	-----------

Pour tous système de distribution spécial, nous consulter

48''

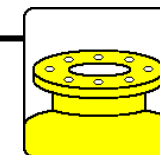
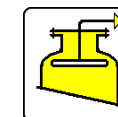
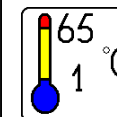
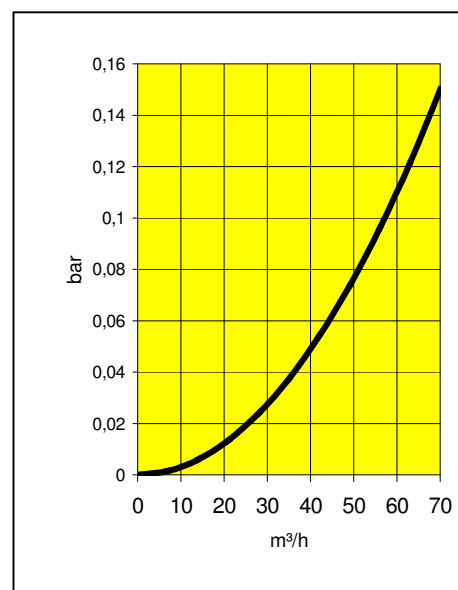
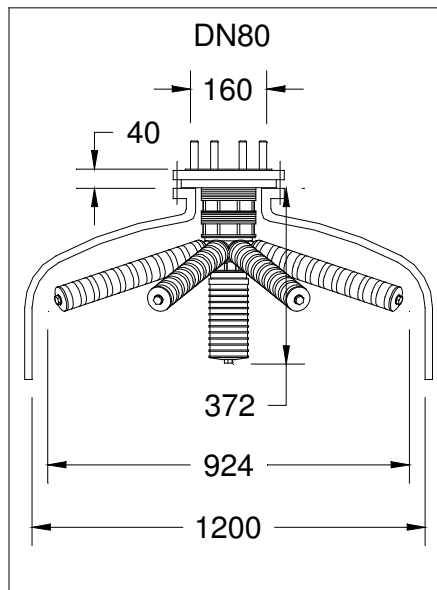
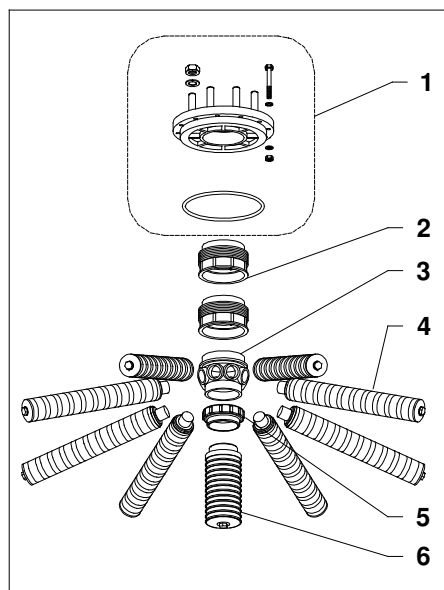

6" FLANGE

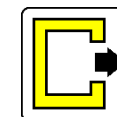

DN80

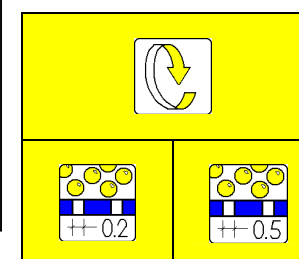

Item Position Article	Description Bezeichnung Description	Dimensions Dimensionen Dimensions	Quantity Menge Quantité	Material Material Matière	Part-Number Artikelnummer N° d' article	
1	Adaptor – Adapter – Adaptateur	6" – DN80	1	PPO	A-3100-03C	A-3100-03C
2	Prolongation – Verlängerungsstück – Prolongation	4" – 50mm	2	PPO	A-3100-05C	A-3100-05C
3	Hub – Verteilerkopf – Distributeur	4" – 3"	1	PP	ATD-H80-00	ATD-H80-00
4	Lateral – Verteilerrohr - Latéral	423 mm	8	PP	A-TH02-423	A-TH05-423
5	Connection – Anschluss - Connection	3" – 2.5"	1	PP	AB-C08-30	AB-C08-30
6	Diffusor – Harzfänger – Diffuseur	2.5" – 180 mm	1	PP	A-2740--	A-2746--



1

A-2748-FU	A-2548-FU
-----------	-----------

Pour tous système de distribution spécial, nous consulter

55''

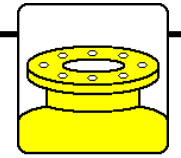

6" FLANGE

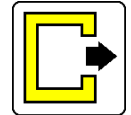

DN80

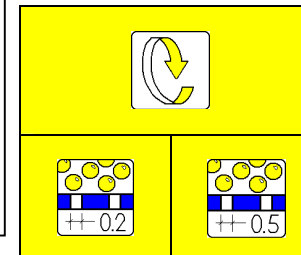
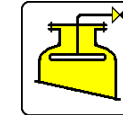
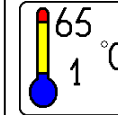
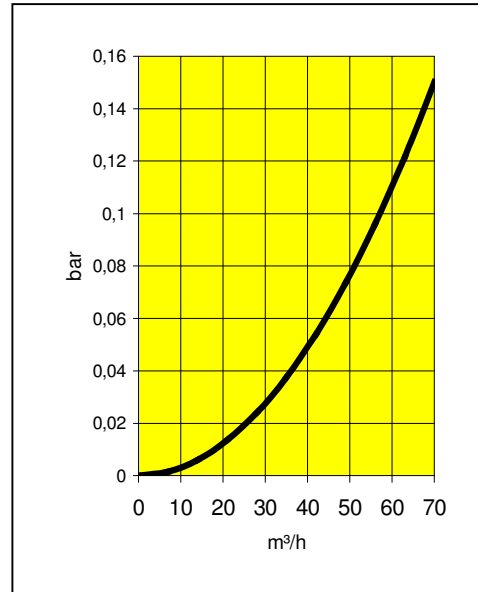
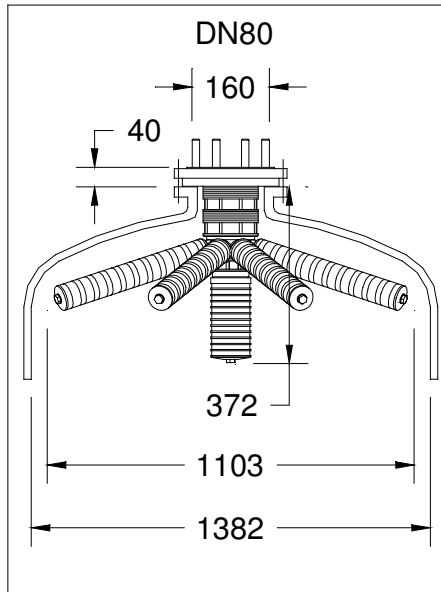
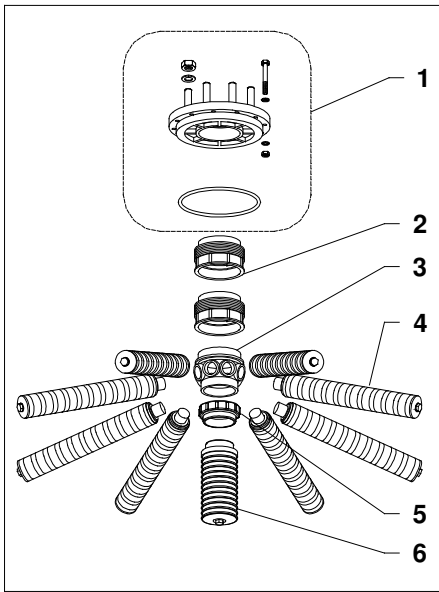

Item Position Article	Description Bezeichnung Description	Dimensions Dimensionen Dimensions	Quantity Menge Quantité	Material Material Matière	Part-Number Artikelnummer N°. d' article	
1	Adaptor – Adapter – Adaptateur	6" – DN80	1	PPO	A-3100-03C	A-3100-03C
2	Prolongation – Verlängerungsstück – Prolongation	4" – 50mm	2	PPO	A-3100-05C	A-3100-05C
3	Hub – Verteilerkopf – Distributeur	4" – 3"	1	PP	ATD-H80-00	ATD-H80-00
4	Lateral – Verteilerrohr - Latéral	516 mm	8	PP	A-TH02-516	A-TH05-516
5	Connection – Anschluss - Connection	3" – 2.5"	1	PP	AB-C08-30	AB-C08-30
6	Diffusor – Harzfänger – Diffuseur	2.5" – 180 mm	1	PP	A-2740--	A-2746--



1

A-2755-FU	A-2555-FU
-----------	-----------

Pour tous système de distribution spécial, nous consulter

63''

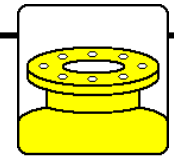

6" FLANGE

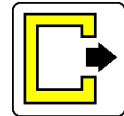

DN80

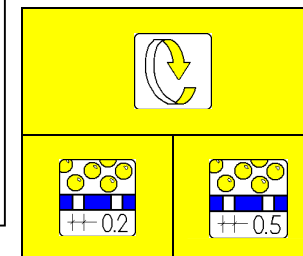
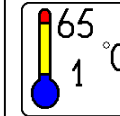
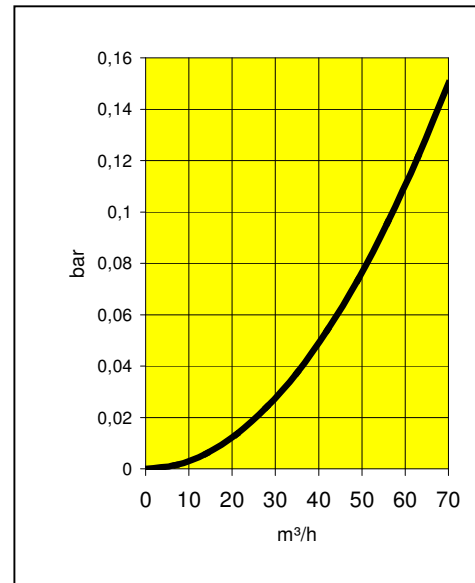
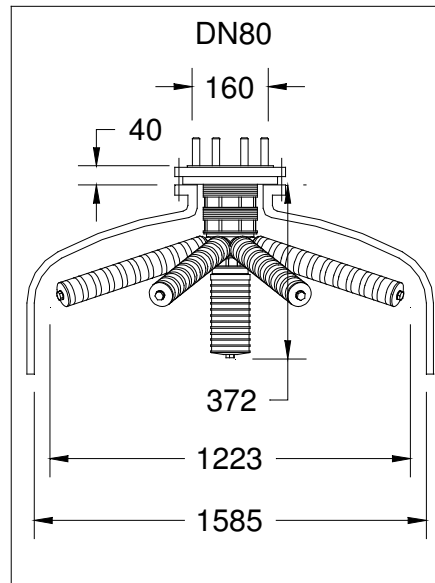
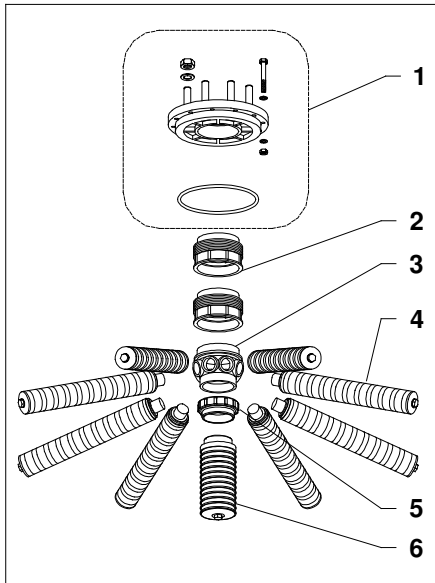

Item Position Article	Identification Bezeichnung Description	Dimensions Dimensionen Dimensions	Quantity Menge Quantité	Material Material Matière	Part-Number Artikelnummer N° d' article	
1	Adaptor – Adapter – Adaptateur	6" – DN80	1	PPO	A-3100-03C	A-3100-03C
2	Prolongation – Verlängerungsstück – Prolongation	4" – 50mm	2	PPO	A-3100-05C	A-3100-05C
3	Hub – Verteilerkopf – Distributeur	4" – 3"	1	PP	ATD-H80-00	ATD-H80-00
4	Lateral – Verteilerrohr - Latéral	578 mm	8	PP	A-TH02-578	A-TH05-578
5	Connection – Anschluss - Connection	3" – 2.5"	1	PP	AB-C08-30	AB-C08-30
6	Diffusor – Harzfänger – Diffuseur	2.5" – 180 mm	1	PP	A-2740--	A-2746--



1

A-2763-FU	A-2563-FU
-----------	-----------

Pour tous système de distribution spécial, nous consulter

42"

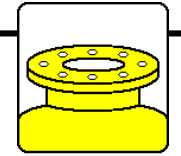

6" FLANGE

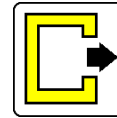
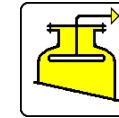
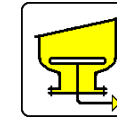
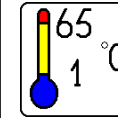
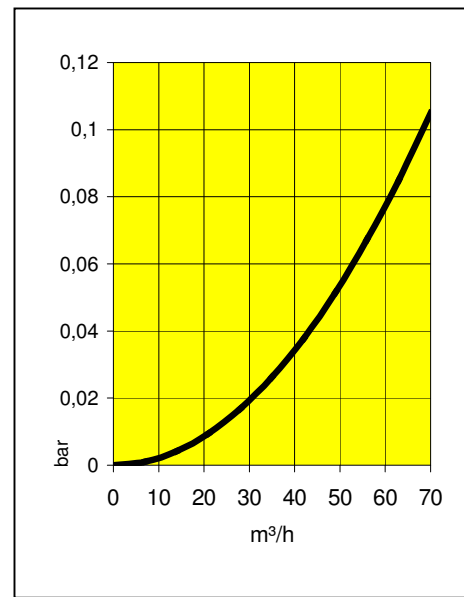
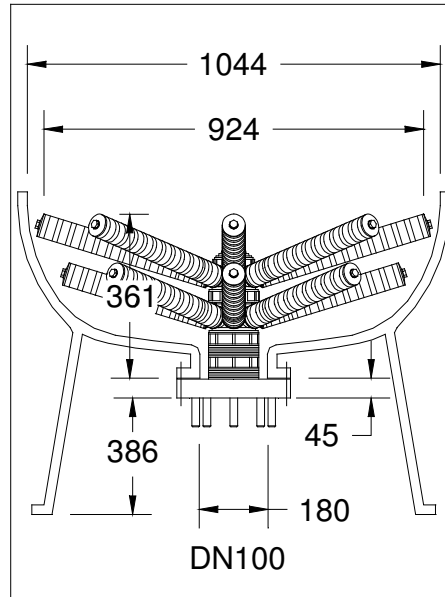
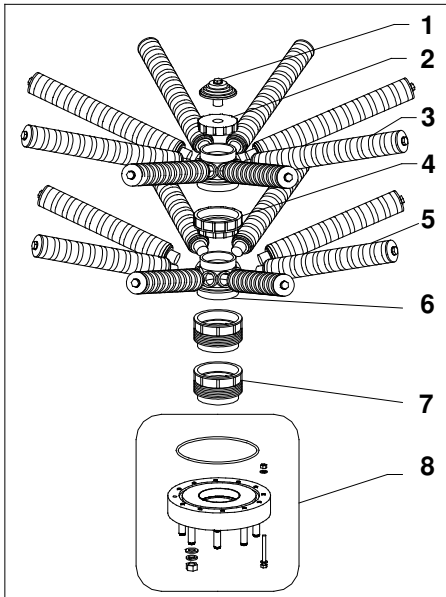

DN100

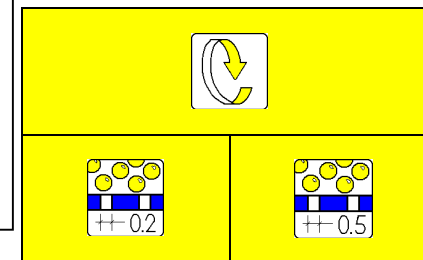

Item Position Article	Description Bezeichnung Description	Dimensions Dimensionen Dimensions	Quantity Menge Quantité	Material Material Matière	Part-Number Artikelnummer N° d' article	
1	Filter Nozzle – Filter Duse - Bouchon Crépine	3 / 4"	1	PP	A-2727-10	A-2727-10
2	Hubcap – Verteilerkopfdeckel – Couvercle Distributeur	3" BSP	1	PP	A-BTC8-30	A-BTC8-30
3	Lateral – Verteilerrohr – Latéral	423 mm	8	PP	A-TH02-423	A-TH05-423
4	Connection – Anschluss -Connection	3" – 4"	1	PP	AB-C08-40	AB-C08-40
5	Lateral – Verteilerrohr – Latéral	361 mm	8	PP	A-TH02-361	A-TH05-361
6	Hub – Verteilerkopf – Distributeur	4" – 3"	2	PP	ATD-H80-00	ATD-H80-00
7	Prolongation – Verlängerungsstück – Prolongation	4" – 50mm	2	PPO	A-3100-05C	A-3100-05C
8	Adaptor – Adapter – Adaptateur	6" – DN100	1	PVC	A-3100-09C	A-3100-09C



1

<b>A-ST10042-02</b>	<b>A-ST10042-05</b>
---------------------	---------------------

Pour tous système de distribution spécial, nous consulter

48''

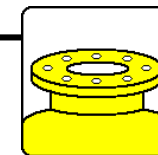

6" FLANGE

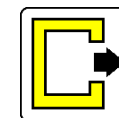
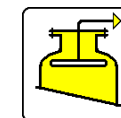
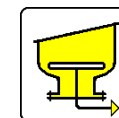
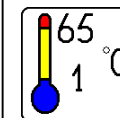
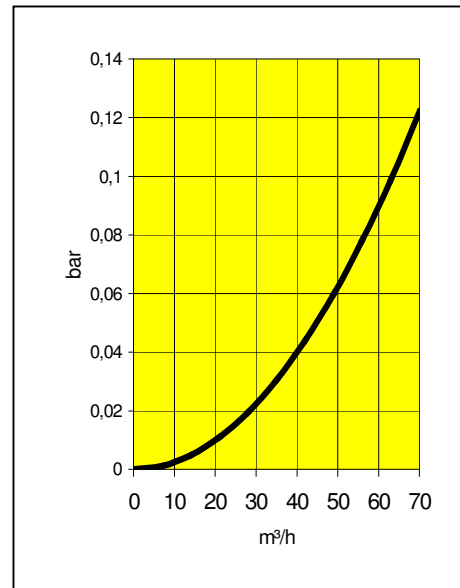
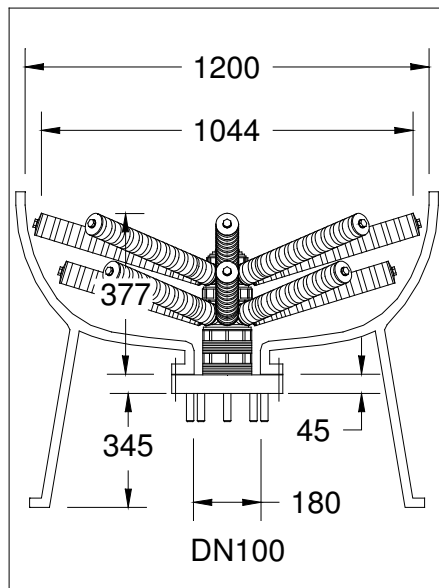
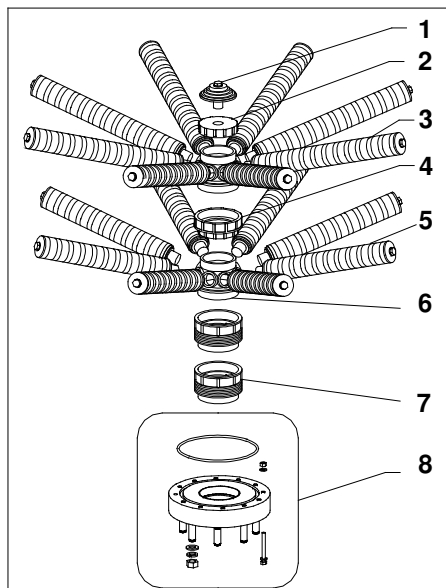

DN100

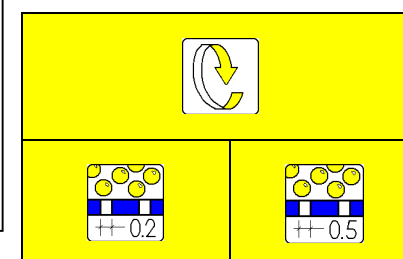

Item Position Article	Description Bezeichnung Description	Dimensions Dimensionen Dimensions	Quantity Menge Quantité	Material Material Matière	Part-Number Artikelnummer N°. d' article	
1	Filter Nozzle – Filter Duse - Bouchon Crépine	3 / 4"	1	PP	A-2727-10	A-2727-10
2	Hubcap – Verteilerkopfdeckel – Couvercle Distributeur	3" BSP	1	PP	A-BTC8-30	A-BTC8-30
3	Lateral – Verteilerrohr – Latéral	485 mm	8	PP	A-TH02-485	A-TH05-485
4	Connection – Anschluss -Connection	3" – 4"	1	PP	AB-C08-40	AB-C08-40
5	Lateral – Verteilerrohr – Latéral	423 mm	8	PP	A-TH02-423	A-TH05-423
6	Hub – Verteilerkopf – Distributeur	4" – 3"	2	PP	ATD-H80-00	ATD-H80-00
7	Prolongation – Verlängerungsstück – Prolongation	4" – 50mm	2	PPO	A-3100-05C	A-3100-05C
8	Adaptor – Adapter – Adaptateur	6" – DN100	1	PVC	A-3100-09C	A-3100-09C



1

A-ST10048-02	A-ST10048-05
--------------	--------------

Pour tous système de distribution spécial, nous consulter



55''

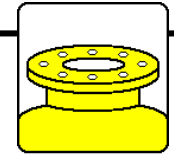

6" FLANGE

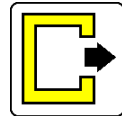
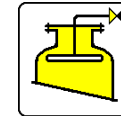
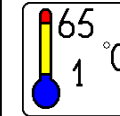

DN100

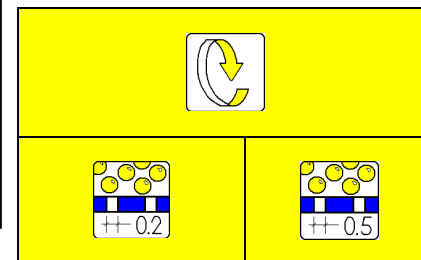
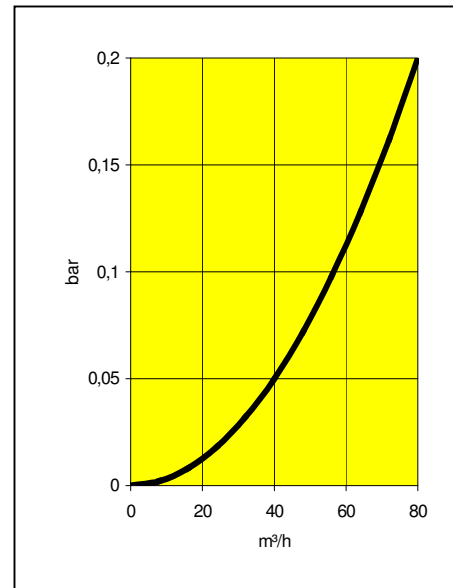
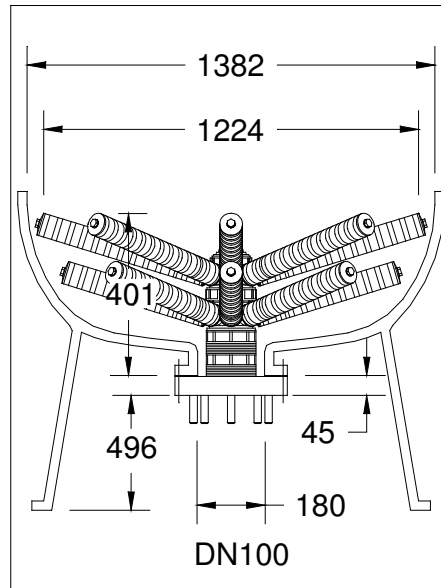
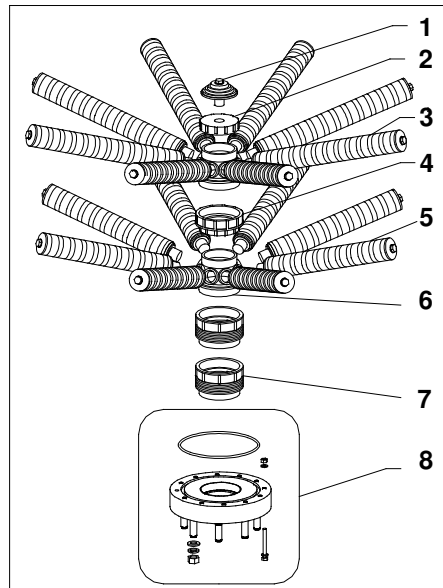

Item Position Article	Description Bezeichnung Description	Dimensions Dimensionen Dimensions	Quantity Menge Quantité	Material Material Matière	Part-Number Artikelnummer N° d' article	
1	Filter Nozzle – Filter Duse - Bouchon Crépine	3 / 4"	1	PP	A-2727-10	A-2727-10
2	Hubcap – Verteilerkopfdeckel – Couvercle Distributeur	3" BSP	1	PP	A-BTC8-30	A-BTC8-30
3	Lateral – Verteilerrohr – Latéral	578 mm	8	PP	A-TH02-578	A-TH05-578
4	Connection – Anschluss -Connection	3" – 4"	1	PP	AB-C08-40	AB-C08-40
5	Lateral – Verteilerrohr – Latéral	516 mm	8	PP	A-TH02-516	A-TH05-516
6	Hub – Verteilerkopf – Distributeur	4" – 3"	2	PP	ATD-H80-00	ATD-H80-00
7	Prolongation – Verlängerungsstück – Prolongation	4" – 50mm	2	PPO	A-3100-05C	A-3100-05C
8	Adaptor – Adapter – Adaptateur	6" – DN100	1	PVC	A-3100-09C	A-3100-09C



1

<b>A-ST10055-02</b>	<b>A-ST10055-05</b>
---------------------	---------------------

Pour tous système de distribution spécial, nous consulter

63''

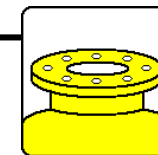

6" FLANGE

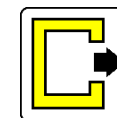
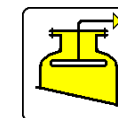
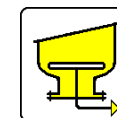
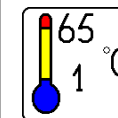
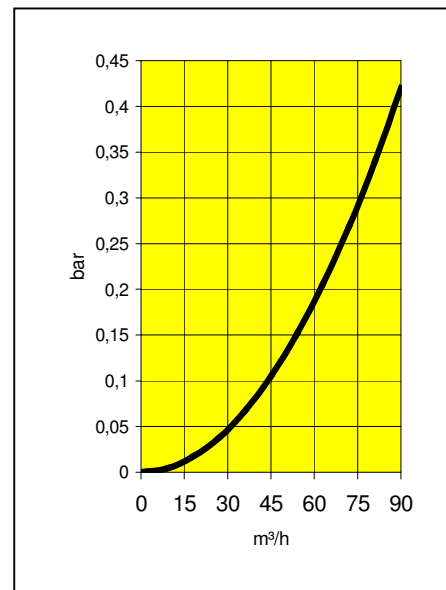
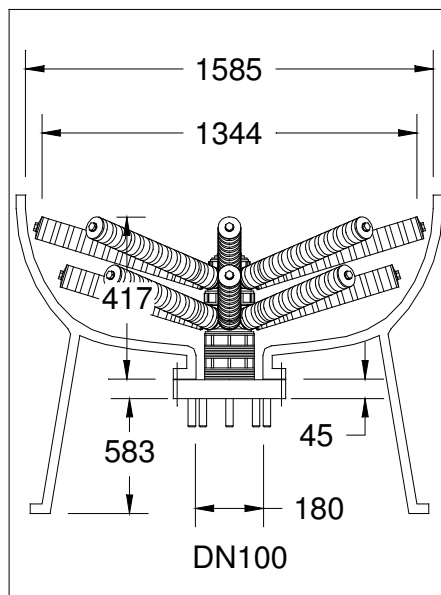
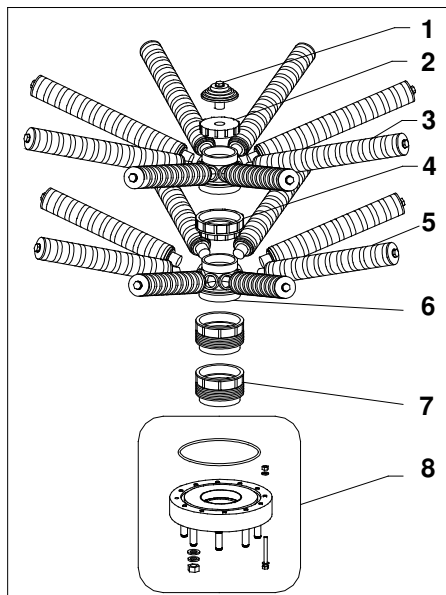

DN100

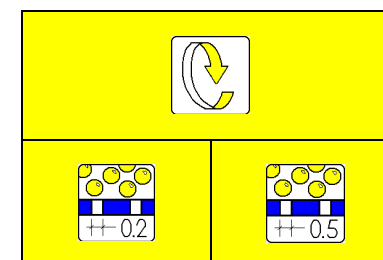

Item Position Article	Identification Bezeichnung Description	Dimensions Dimensionen Dimensions	Quantity Menge Quantité	Material Material Matière	Part-Number Artikelnummer N°. d' article	
1	Filter Nozzle – Filter Duse - Boucon Crépine	3 / 4"	1	PP	A-2727-10	A-2727-10
2	Hubcap – Verteilerkopfdeckel – Couvercle Distributeur	3" BSP	1	PP	A-BTC8-30	A-BTC8-30
3	Lateral – Verteilerrohr – Latéral	640 mm	8	PP	A-TH02-640	A-TH05-640
4	Connection – Anschluss -Connection	3" – 4"	1	PP	AB-C08-40	AB-C08-40
5	Lateral – Verteilerrohr – Latéral	578 mm	8	PP	A-TH02-578	A-TH05-578
6	Hub – Verteilerkopf – Distributeur	4" – 3"	2	PP	ATD-H80-00	ATD-H80-00
7	Prolongation – Verlängerungsstück – Prolongation	4" – 50mm	2	PPO	A-3100-05C	A-3100-05C
8	Adaptor – Adapter – Adaptateur	6" – DN100	1	PVC	A-3100-09C	A-3100-09C



1

A-ST10063-02	A-ST10063-05
--------------	--------------

Pour tous système de distribution spécial, nous consulter

# 14"-16"-18"

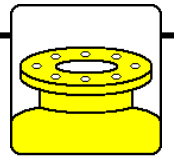
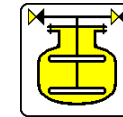
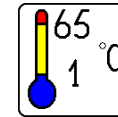
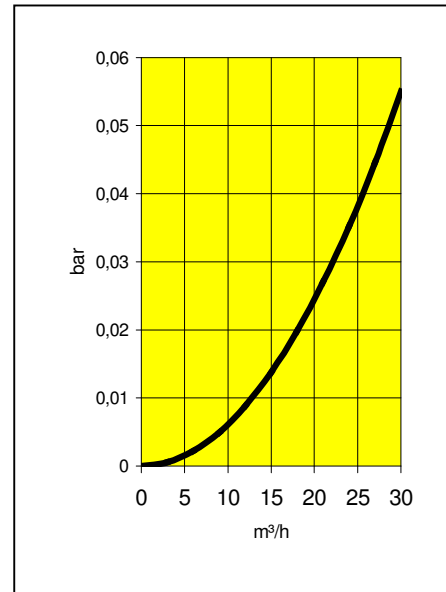
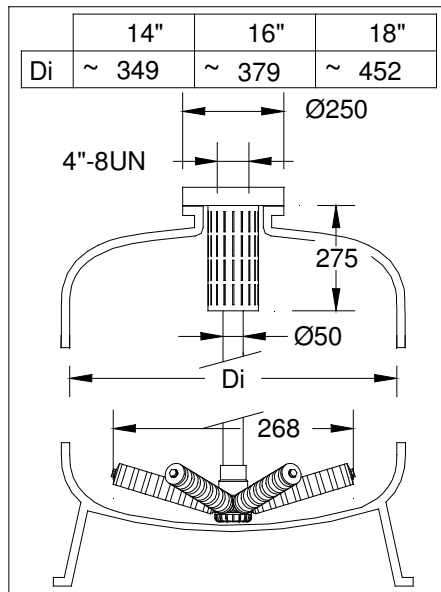
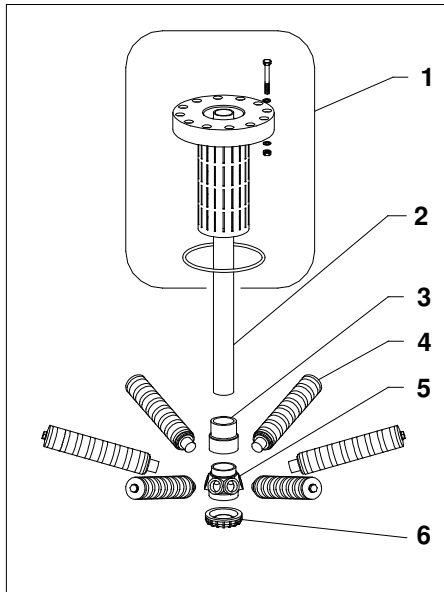

6" FLANGE

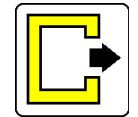

Ø50-4"

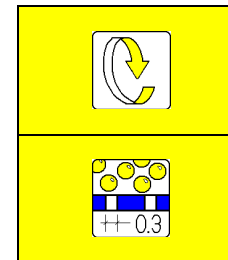

Item Position Article	Identification Bezeichnung Description	Dimensions Dimensionen Dimensions	Quantity Menge Quantité	Material Material Matière	Part-Number Artikelnummer N° d' article
1	Adapter - Adapter - Adaptateur	6"- 4" 8UN	1	PVC	A-3100-10C
2	Riser tube - Steigrohr - Tube Plongeur	Ø50mm	1680 mm	PVC	A-PIPE-50
3	Reducing Bush - Reduktions Nippel - Réduction courte taraudée	Ø50mm - 2"	1	PVC	A-2600-63
4	Lateral – Verteilerrohr – Latéral	113 mm	6	PP	A-TH02-113
5	Hub – Verteilerkopf – Distributeur	2.5" - 2"	1	PP	ATD-H60-00
6	Hubcap – Verteilerkopfdeckel – Couvercle Distributeur	2.5"	1	PP	AC-H60-00



1

**A-TF16-025**

Pour tous système de distribution spécial, nous consulter

21" - 24"

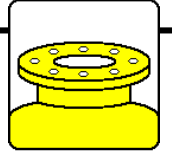
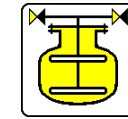
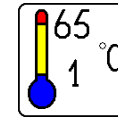
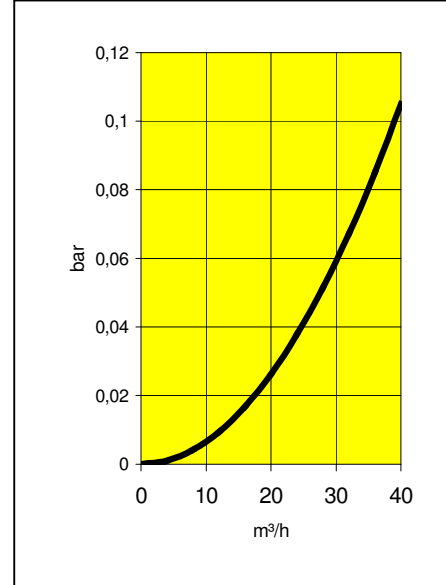
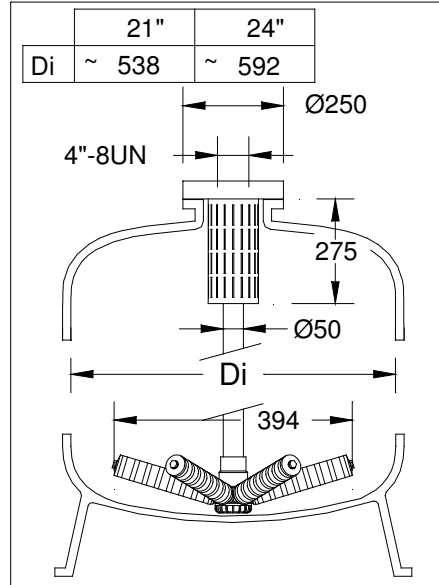
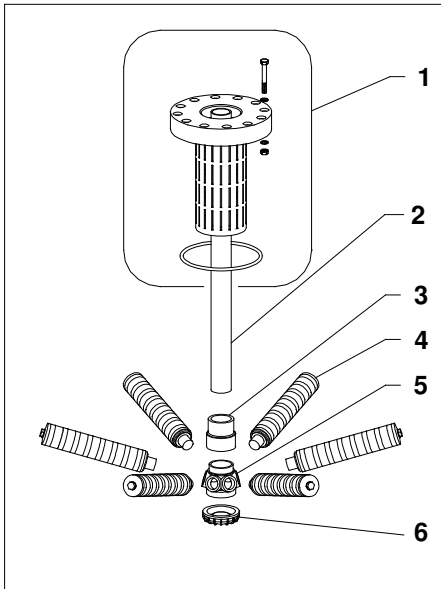

6" FLANGE

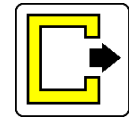

Ø50-4"

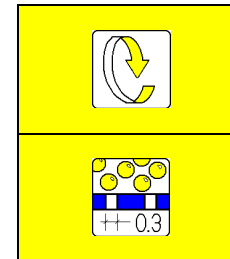

Item Position Article	Identification Bezeichnung Description	Dimensions Dimensionen Dimensions	Quantity Menge Quantité	Material Material Matière	Part-Number Artikelnummer N° d' article
1	Adapter - Adapter - Adaptateur	6"- 4" 8UN	1	PVC	A-3100-10C
2	Riser tube - Steigrohr - Tube Plongeur	Ø50mm	1800 mm	PVC	A-PIPE-50
3	Reducing Bush - Reduktions Nippel - Réduction courte taraudée	Ø50mm - 2"	1	PVC	A-2600-63
4	Lateral - Verteilerrohr - Latéral	175 mm	6	PP	A-TH02-175
5	Hub - Verteilerkopf - Distributeur	2.5" - 2"	1	PP	ATD-H60-00
6	Hubcap - Verteilerkopfdeckel - Couvercle Distributeur	2.5"	1	PP	AC-H60-00



1

A-TF21-025

Pour tous système de distribution spécial, nous consulter

30"

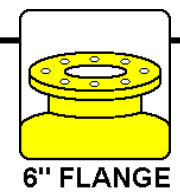
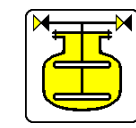
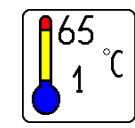
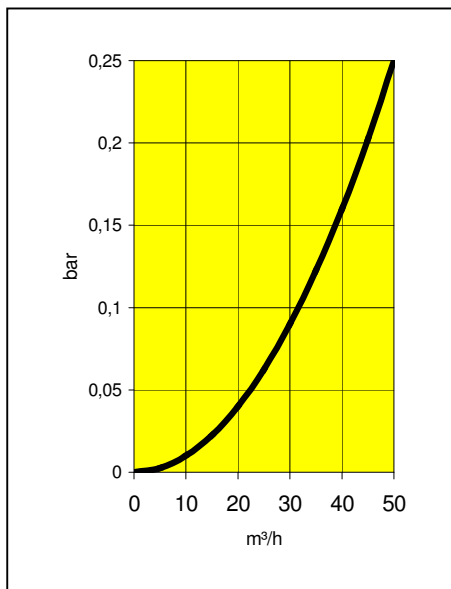
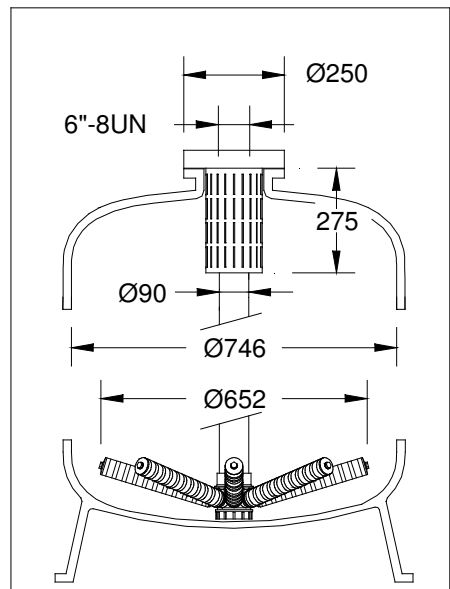
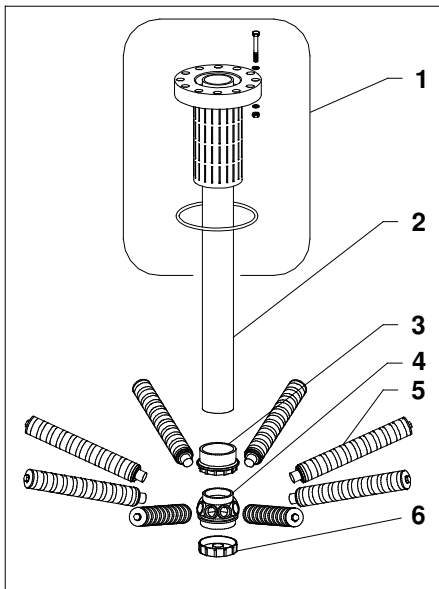

6" FLANGE



Ø90-6"

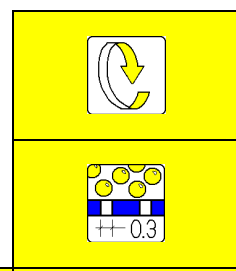

Item Position Article	Identification Bezeichnung Description	Dimensions Dimensionen Dimensions	Quantity Menge Quantité	Material Material Matière	Part-Number Artikelnummer N° d' article
1	Adapter - Adapter - Adaptateur	6"- 6" 8UN	1	PVC	A-3100-11C
2	Riser tube - Steigrohr - Tube Plongeur	Ø90mm	1850 mm	PVC	A-PIPE-90
3	Reducing Bush - Reduktions Nippel - Réduction courte taraudée	Ø90mm - 3"	1	PVC	AB-GC8-30
4	Hub - Verteilerkopf - Distributeur	4" - 3"	1	PP	ATD-H80-00
5	Lateral - Verteilerrohr - Latéral	268 mm	8	PP	A-TH02-268
6	Hubcap - Verteilerkopfdeckel - Couvercle Distributeur	4"	1	PP	AD-H80-00



1

**A-TF30-025**

Pour tous système de distribution spécial, nous consulter

36"

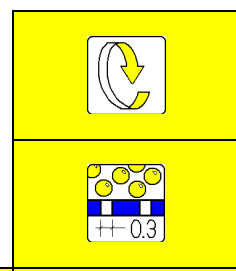
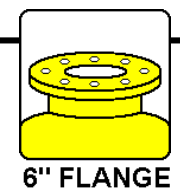
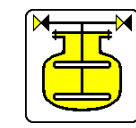
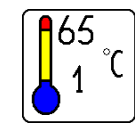
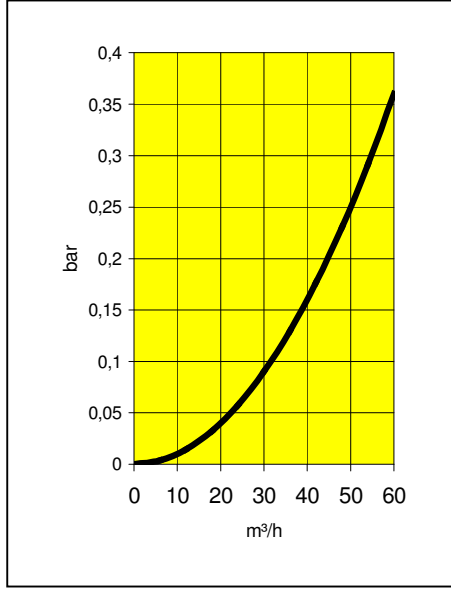
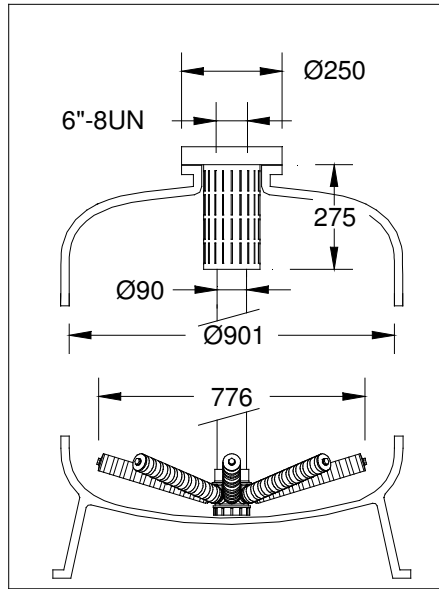
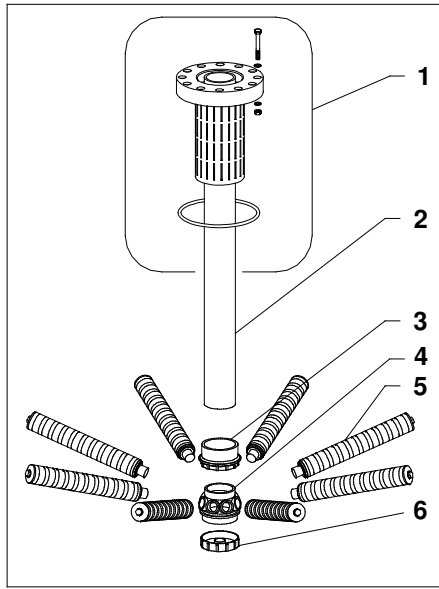

Item Position Article	Identification Bezeichnung Description	Dimensions Dimensionen Dimensions	Quantity Menge Quantité	Material Material Matière	Part-Number Artikelnummer N° d' article
1	Adapter - Adapter - Adaptateur	6" - 6" 8UN	1	PVC	A-3100-11C
2	Riser tube - Steigrohr - Tube Plongeur	Ø90mm	1850 mm	PVC	A-PIPE-90
3	Reducing Bush - Reduktions Nippel - Réduction courte taraudée	Ø90mm - 3"	1	PVC	AB-GC8-30
4	Hub - Verteilerkopf - Distributeur	4" - 3"	1	PP	ATD-H80-00
5	Lateral - Verteilerrohr - Latéral	330 mm	8	PP	A-TH02-330
6	Hubcap - Verteilerkopfdeckel - Couvercle Distributeur	4"	1	PP	AD-H80-00



**A-TF36-025**

Pour tous système de distribution spécial, nous consulter

42"

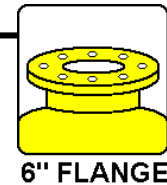
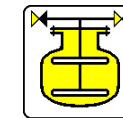
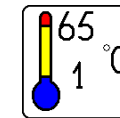
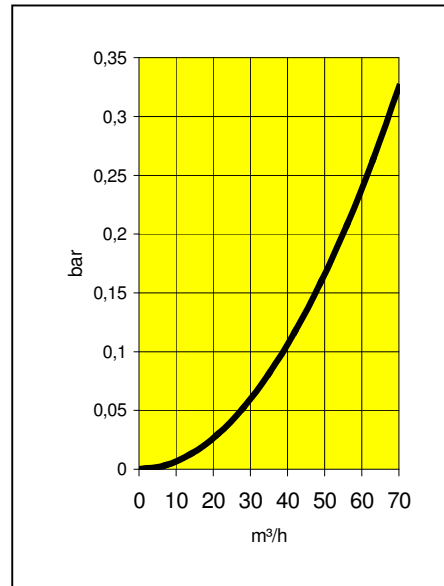
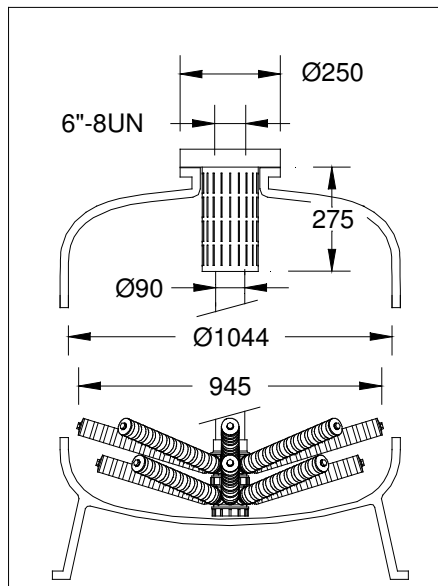
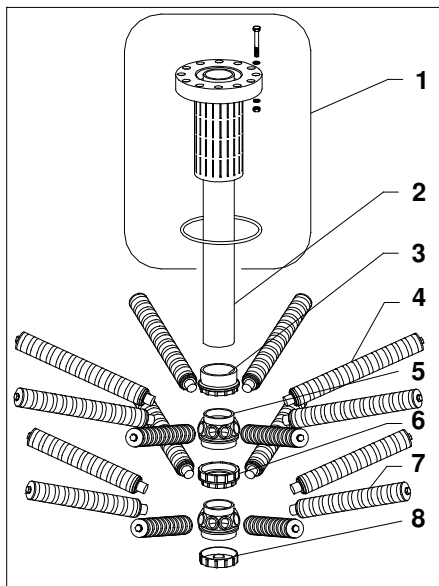

6" FLANGE



Ø90-6"

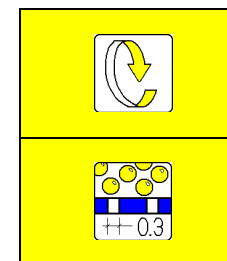

Item Position Article	Identification Bezeichnung Description	Dimensions Dimensionen	Quantity Menge Quantité	Material Material Matière	Part-Number Artikelnummer N° d' article
1	Adapter - Adapter - Adaptateur	6"- 6" 8UN	1	PVC	A-3100-11C
2	Riser tube - Steigrohr - Tube Plongeur	Ø90mm	1850 mm	PVC	A-PIPE-90
3	Reducing Bush - Reduktions Nippel - Réduction courte taraudée	Ø90mm - 3"	1	PVC	AB-GC8-30
4	Lateral – Verteilerrohr – Latéral	423 mm	8	PP	A-TH02-423
5	Hub – Verteilerkopf – Distributeur	4" - 3"	2	PP	ATD-H80-00
6	Connection - Anschluss - Connection	3" - 4"	1	PP	AB-C08-40
7	Lateral – Verteilerrohr – Latéral	361 mm	8	PP	A-TH02-361
8	Hubcap – Verteilerkopfdeckel – Couvercle Distributeur	4"	1	PP	AD-H80-00



1

**A-TF42-025**

Pour tous système de distribution spécial, nous consulter

48"

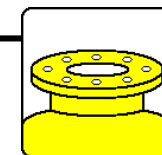
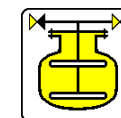
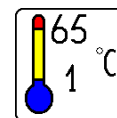
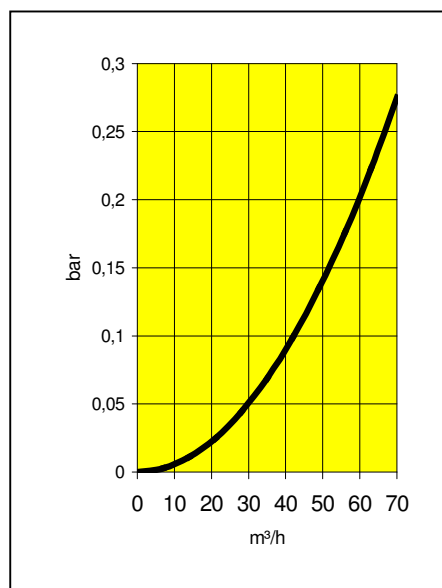
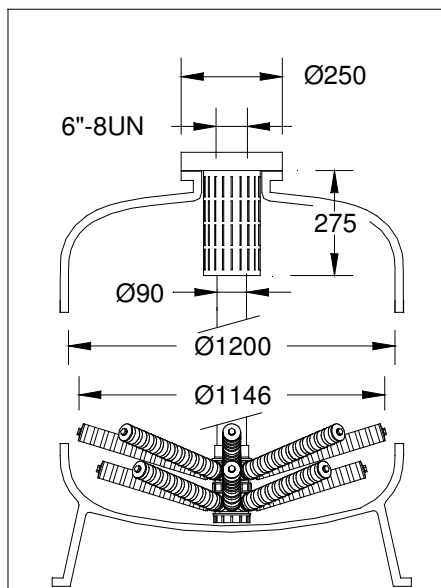
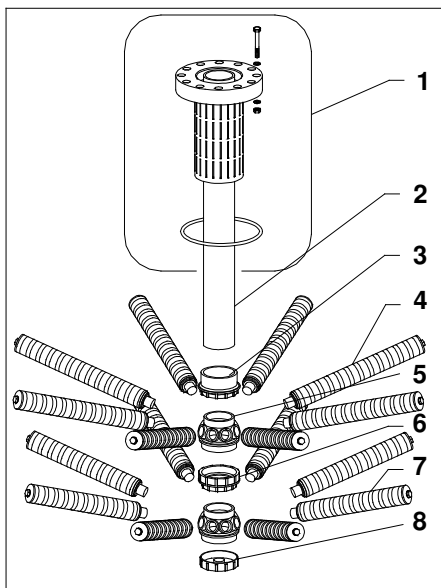

6" FLANGE

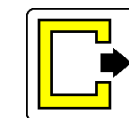

Ø90-6"

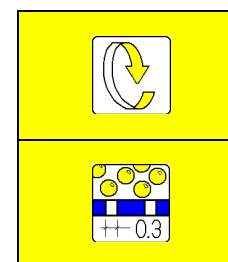

Item Position Article	Identification Bezeichnung Description	Dimensions Dimensionen Dimensions	Quantity Menge Quantité	Material Material Matière	Part-Number Artikelnummer N° d' article
1	Adapter - Adapter - Adaptateur	6"- 6" 8UN	1	PVC	A-3100-11C
2	Riser tube - Steigrohr - Tube Plongeur	Ø90mm	1850 mm	PVC	A-PIPE-90
3	Reducing Bush - Reduktions Nippel - Réduction courte taraudée	Ø90mm - 3"	1	PVC	AB-GC8-30
4	Lateral – Verteilerrohr – Latéral	485 mm	8	PP	A-TH02-485
5	Hub – Verteilerkopf – Distributeur	4" - 3"	2	PP	ATD-H80-00
6	Connection - Anschluss - Connection	3" - 4"	1	PP	AB-C08-40
7	Lateral – Verteilerrohr – Latéral	423 mm	8	PP	A-TH02-423
8	Hubcap – Verteilerkopfdeckel – Couvercle Distributeur	4"	1	PP	AD-H80-00



1

**A-TF48-025**

Pour tous système de distribution spécial, nous consulter